

Standard AC Motors

Installation

Overview, Product Series

Constant Speed Motors

Three-Phase Induction Motors

Single-Phase Induction Motors

Reversible Motors

Electromagnetic Brake Motors

Clutch & Brake Motors

Low-Speed Synchronous Motors

Torque Motors

Watertight, Dust-Resistant Motors

Right-Angle Gearheads

Linear Heads

Brake Pack

Accessories

Installation

Installation

Installation

Handling the Motor

Handling

Always carry the motor by placing it in the original package. If the motor must be carried by itself during testing or for assembly into equipment, take note of the following points:

- Hold the motor so that the output shaft points upward.
- Hold the motor not by its output shaft or motor cable, but by the motor body.

Storage

Temperature and humidity are important considerations since the storage condition has an influence on the life of motors. Storage in places where there are large temperature and humidity variations will reduce the stator's insulation performance. Moreover, leaving the motor for extended periods in places with high temperature and humidity is likely to lead to grease deterioration inside the ball bearing and corrosion. When storing for long periods, it is recommended to coat the output shaft with an anti-corrosion agent, seal the motor in a polyethylene bag and store in a place with normal temperature and humidity.

Installation Conditions

Install the motor, gearhead and brake pack in a location that meets the following conditions. Use in a location that does not satisfy these conditions could damage the product.

- Indoors (This product is designed and manufactured to be installed within another device.)
- Ambient temperature: As this varies by product, please confirm on the individual product page.
- Ambient humidity: 85% or less (non-condensing)
- Not exposed to explosive, flammable or corrosive gases
- Not exposed to direct sunlight
- Not exposed to dust
- Not exposed to water, oil or other liquids
- A place where heat can escape easily
- Not exposed to continuous vibration or excessive impact
- Installation Category II, Pollution Degree 2, Class I Equipment
- Only for the products that are certified by EN/IEC Standards and conform to EN/IEC Standards. Installation Category III, Pollution Degree 3 for some products

Motor and Gearhead Combinations



When connecting gearheads, be sure to match the pinion shafts and frame size. For details, refer to the page where each product is listed.

Decimal Gearhead Combinations

The **GN** and **GE** type gearheads are available with decimal gearheads (sold separately) with a gear ratio of 10:1. They should be used in applications in which large enough gear ratio cannot be attained with a single gearhead.

Note

- Although the gear ratio of 10:1 of the decimal gearhead theoretically translates into 10 times increase of torque available on the output shaft, it is not possible to make full use of this torque. The permissible torque in actual use is limited by the physical construction of the gearhead and is expressed as its rated maximum torque.

Gearhead and Motor Installation

Motor Installation Direction

Motors can be mounted freely in any direction as shown below. Regardless of how the motor is mounted, take care not to apply a radial load or axial load on the shaft. Make sure the cable does not contact the mounting surface causing undesirable force on the cable.

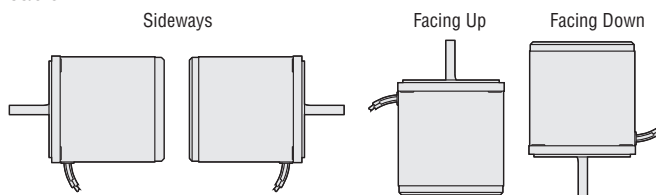

Mounting Motor/Gearhead to Machinery

The motor flange is provided with a pilot section that serves as a guide not only when assembling the motor and gearhead but also when mounting the motor onto machinery.

The following figures show the mounting examples of the motor and gearhead onto machinery. Dedicated mounting bracket shown below is provided as an accessory.

- Mounting Brackets → Page C-196



Dedicated Mounting Bracket

When mounting motors that have a built-in cooling fan at the rear, leave a space 10 mm (0.39 in.) or more behind the fan cover or make ventilation holes so as not to block the cooling intake.

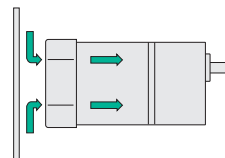

● Dimensions of Mounting Holes

The dimension of the four motor mounting holes is shown as pitch diameter in the dimensions for each product.

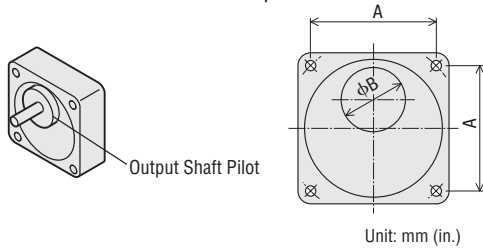

Motor Frame Size	A	B
□60 (□2.36)	49.50 (1.949)	24 (0.94)
□70 (□2.76)	57.98 (2.283)	30 (1.18)
□80 (□3.15)	66.47 (2.617)	34 (1.34)
□90 (□3.54)	73.54 (2.895)	34 (1.34), 36 (1.42)*
□104 (□4.09)	84.85 (3.341)	42 (1.65)

* The dimensions vary depending on the product.

● B indicates the dimensions for the output shaft pilot of the gearhead. Open mounting holes in +1 mm (0.039 in.) or more.

● Mounting the Load

◇ For Parallel Shaft Gearhead, Round Shaft Type

The output shafts of high-power gearheads are provided with a key slot to secure the load, while the output shafts of gearheads with comparatively low power have been given a shaft flat. Round shaft motors come in two types: those with or without a shaft flat on the motor output shaft.

● When Using a Shaft Flat

With a shaft flat, use a locking screw to ensure that the load does not slip.

We recommend using double point screws or other screws with strong locking power.

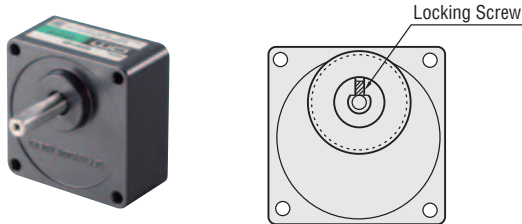

● When Using a Key Slot

Secure the load shaft using the key included with the gearhead after machining the key slot on the equipment to be connected (sprocket etc.).

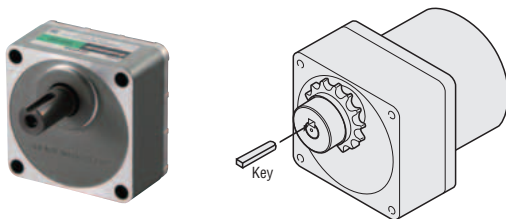

● When Using an Output Shaft End Tapped Hole

Use the output shaft end tapped hole [M5 10 mm (0.39 in.) deep min. or M6 12 mm (0.47 in.) deep min.] to help prevent the transmission part from becoming detached.

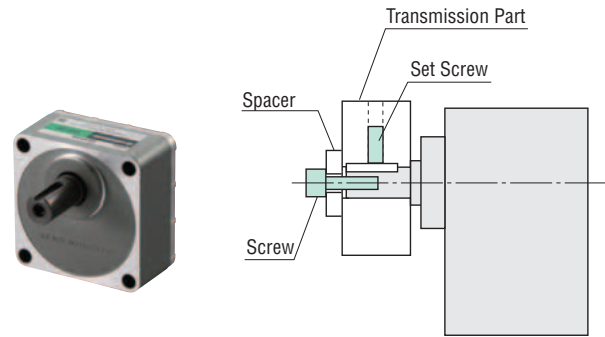

On round shaft types, the output shaft is machined to the accuracy of h7 in dimension and 2/100 or less in eccentricity. Therefore, when connecting a load to the shaft of the device, take measurements using a dial gauge or similar instrument so that there is no eccentricity. When the shaft center of two shafts does not align, use a flexible coupling (**MCL** coupling) etc. to avoid unnecessary strain on the shaft.

The same procedure should be applied when securing a load to gearheads.

● Flexible couplings → Page C-201

◇ For Right-Angle Gearhead

Mounting method for right-angle, hollow shaft types

→ See the Oriental Motor website

Overview, Product Series

Constant Speed Motors

Three-Phase Induction Motors

Single-Phase Induction Motors

Reversible Motors

Electromagnetic Brake Motors

Clutch & Brake Motors

Low-Speed Synchronous Motors

Torque Motors

Watertight, Dust-Resistant Motors

Right-Angle Gearheads

Linear Heads

Brake Pack

Accessories

Installation

◇ Right-Angle Geared Type

Installation of the load shaft varies according to the fixing method. Please install as shown below.

- Install the load shaft to the hollow output shaft by aligning the center of the hollow shaft with that of the load shaft.
- The hollow output shaft has a key slot. Machine a matching key slot on the load shaft and use the supplied key to fix the two shafts across the slots.
- The recommended tolerance of the load shaft is h7.
- If the motor is intended to receive large shocks due to frequent instantaneous stops or carry a large radial load, use a stepped load shaft.

Note

- When installing the load shaft to the hollow output shaft, be careful not to damage the hollow output shaft or bearing.
- To prevent sticking, apply a coat of grease on the exterior surface of the load shaft and interior surface of the hollow output shaft.
- Do not attempt to modify or machine the hollow output shaft. This may damage the bearing and cause failure.

◇ Fixing Using an End Plate

● Stepped Load Shaft

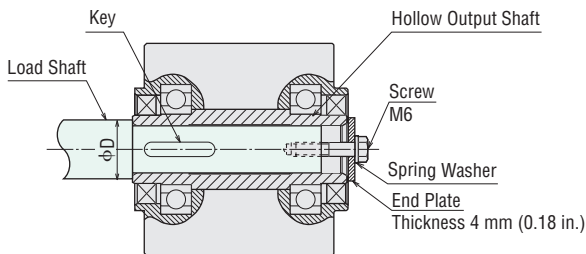

◇ Fixing Using a Retaining Ring for Hole

● Stepped Load Shaft

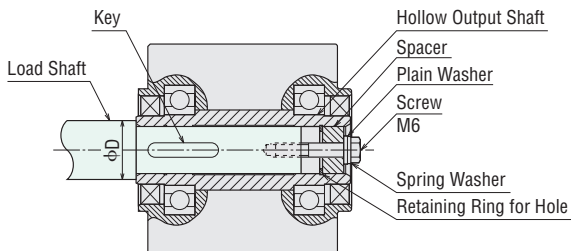

- After installing the load shaft, install the safety cover.

● Straight Load Shaft

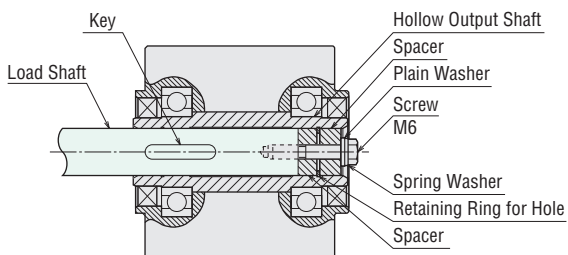

● Recommended Load Shaft Installation Dimensions

Unit: mm (in.)

Product Name	51K
Inner Diameter of Hollow Shaft (H8)	$\phi 25^{+0.033}_0$ ($\phi 0.9843^{+0.0013}_0$)
Shaft Diameter of Load Shaft (h7)	$\phi 25^0_{-0.021}$ ($\phi 0.9843^0_{-0.0008}$)
Nominal Hole Diameter of Retaining Ring	$\phi 25$ ($\phi 0.98$) C type retaining ring
Outer Diameter of Stepped Shaft ϕD	$\phi 40$ ($\phi 1.57$)
Spacer Thickness	6 (0.24)

- Retaining rings for holes, spacers, screws and other parts used to install the load shaft are not included. The customer must supply these.

◇ Length of Load Shaft

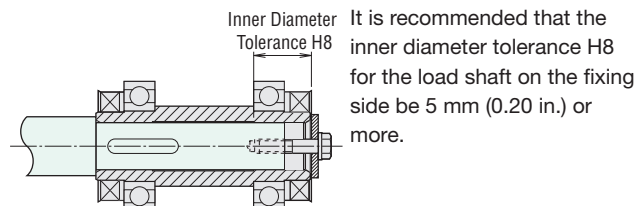

● Permissible Radial Load and Permissible Axial Load

When a chain, gear, belt, etc. is used as the transmission mechanism, the radial load (a load applied in the right-angle direction of the output shaft) is always applied on the output shaft. Since the radial load acts on the output shaft and its bearing directly, it has an influence on the life of gearhead. Be careful not to exceed the permissible value (specifications value).

If the radial load greatly exceeds the permissible value, it will lead to the shortening of bearing life or damage to the bearing, as well as warping of the output shaft or fatigue loss after repeated load. In such situations, a support such as the one shown to the right must be designed to take up the radial load.

Since connecting a transmission mechanism directly to the output shaft exerts an unbalanced load on the shaft, connect mechanisms as close to the gearhead as possible.

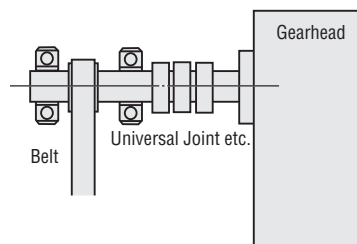

When using transmission mechanisms involving helical gears or worm gears, they are subject not only to radial load but to axial load (a load applied in the axial direction of the output shaft) as well. Ensure that the axial load does not exceed the permissible value in the table.

Refer to page C-18 for the calculating formula of radial load, and page C-17 for the permissible value (specifications value) of radial load or axial load.

Connecting the Motor

Lead Wire for Power Supply

For power supply, use a thicker lead wire than the motor lead wire.
 Frame size 42 mm (1.65 in.): AWG24, AWG22
 Frame size 60 mm (2.36 in.) or larger: AWG20

How to Connect a Capacitor

When motors are running, a voltage of almost twice the motor power supply voltage is applied across the terminals of the capacitor. The terminal should be insulated for safety. Use the capacitor cap provided to insulate the terminals.

4-Terminal Capacitor

The capacitor has 4 terminals, terminal A is connected internally to terminal B, terminal C is connected internally to terminal D, as shown in the illustration. Electrically, this creates 2 terminals.

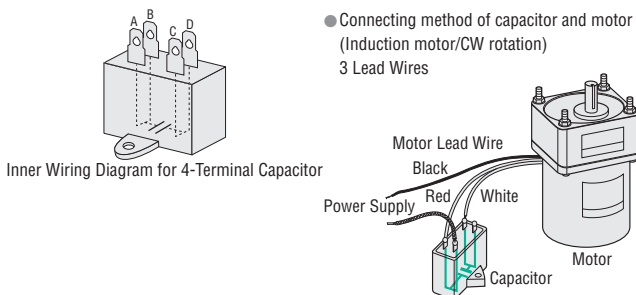

Contact Capacity

Connect a CR circuit for surge suppression shown on the right to protect the contact.

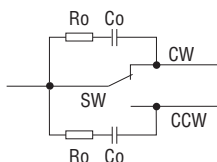

Code	Contact Capacity, Others	Note
SW	125 VAC 5 A min. or 250 VAC 5 A min. (Inductive load)	-
Ro, Co	Ro = 5~200 Ω Co = 0.1~0.2 μF 200 W (400 W)	Accessories EPCR1201-2 Page C-208

Grounding the Motor

Ground the protective earth terminal ⊕ of the motor.



Applicable crimp terminal:
 Round terminal with insulation
 Terminal screw size: M4
 Applicable lead wire: AWG18 min.

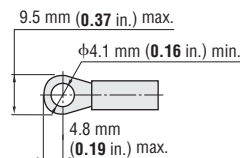

For motors without a protective earth terminal, any one of the four mounting bolts may be used to attach the ground wire to the motor case. If necessary, remove all paint that may impede conductivity around the bolt mounting hole.



Terminal Box Type (Reference)

Connect the ground wire to the protective earth terminal inside the terminal box.



Conduit Box Type

Conduit box mounted motors have a ground lead wire (green wire). Connect the ground wire to this green lead wire.

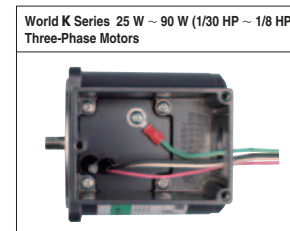
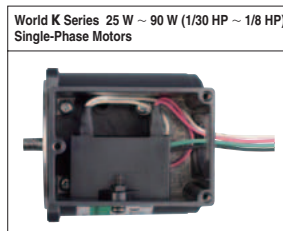

Overview, Product Series

Constant Speed Induction Motors

Three-Phase Induction Motors

Single-Phase Induction Motors

Reversible Motors

Electromagnetic Brake Motors

Clutch & Brake Motors

Low-Speed Synchronous Motors

Torque Motors

Watertight, Dust-Resistant Motors

Right-Angle Gearheads

Linear Heads

Brake Pack

Accessories

Installation

● Motor with Terminal Box

◇ Terminal Box: **KIS Series, KI Series**

Material of terminal box: Die cast aluminum

Applicable cable diameter: $\phi 7 \sim \phi 13$ mm
 ($\phi 0.28 \sim \phi 0.51$ in.)
 $\phi 8 \sim \phi 13$ mm
 ($\phi 0.31 \sim \phi 0.51$ in.) (**KIS Series Three-Phase Motor Round Shaft Type**)

Applicable lead wire: AWG18 min.

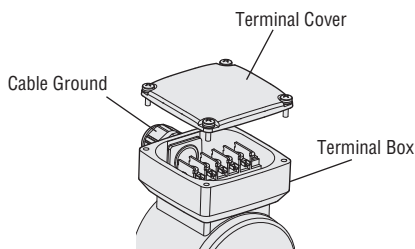

● Cable entry is possible at four sides of the terminal box.

● Applicable Crimp Terminals

Round Terminal with Insulation

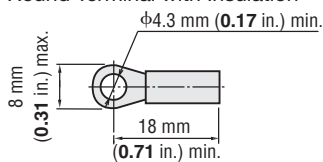

◇ Terminal Box: **BH Series Electromagnetic Brake Motor**

Material of terminal box: Die cast aluminum

Applicable cable diameter: $\phi 8 \sim \phi 12$ mm ($\phi 0.31 \sim \phi 0.47$ in.)
 Applicable lead wire: AWG18 min.

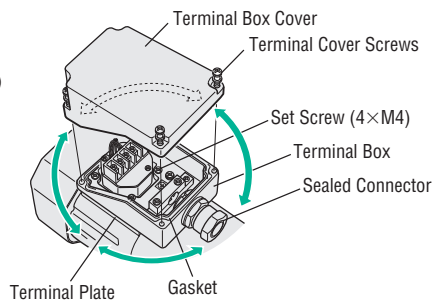

● Cable entry is possible at four sides of the terminal box.

● Applicable Crimp Terminals

Round Terminal with Insulation

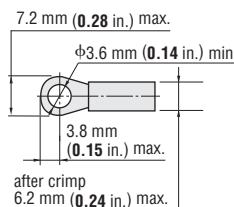

U-Shape Terminal with Insulation

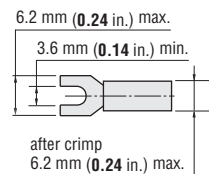

◇ Terminal Box: **World K Series [25 W~90 W (1/30 HP~1/8 HP)], BH Series**

Material of terminal box: Plastic

Applicable cable diameter: $\phi 6 \sim \phi 12$ mm
 ($\phi 0.24 \sim \phi 0.47$ in.)

Applicable lead wire: AWG24~12

Strip length: 8 mm (0.315 in.)

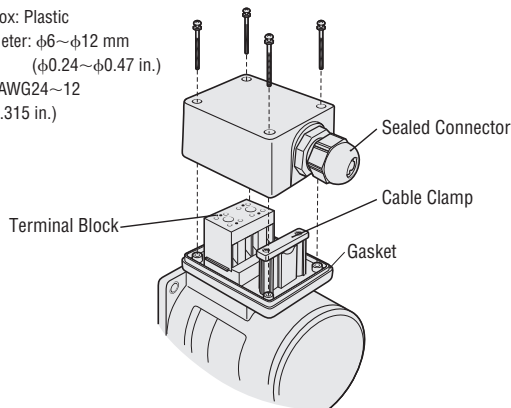

● When connecting cables to the terminal block, loosen the screw on the insertion port for the lead wire and insert the lead wire with a screw driver. Then tighten the screw securely.

● Cable entry is possible at one side of the terminal box.

◇ Conduit Box Type

Conduit box type is available for induction motors.

- Open the terminal box and connect the wires.
- Use applicable cable ground and conduit for conduit opening.
- After connecting, close the terminal box with the terminal cover.

**Single-Phase 25 W (1/30 HP),
 40 W (1/19 HP) / Three-Phase**

**Single-Phase 60 W (1/12 HP),
 90 W (1/8 HP)**

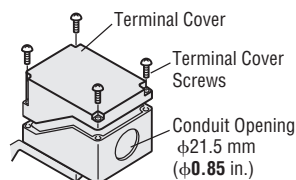
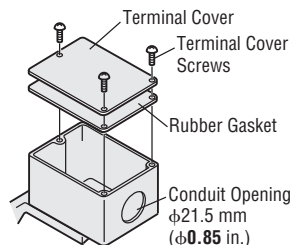

■ Dimensions for Installation Screws

● KIIS Series Right-Angle Geared Type

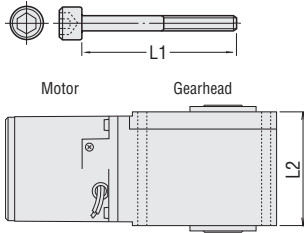

Product Name	Installation Screw		L2 mm (in.)
	L1 mm (in.)	Size	
5IK	110 (4.33)	M8 P1.25	98 (3.86)

- Installation screws: 4 flat washers, spring washers are included.
- Stainless steel screws are included.

● KIIS Series, KII Series, DSC Series

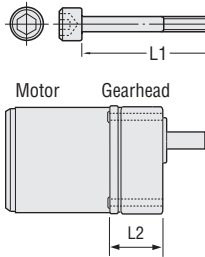

Product Name	Installation Screw		L2 mm (in.)
	L1 mm (in.)	Size	
2GV5A~25A	50.8 (2)	No.8-32 UNC	41 (1.61)
2GV30A~120A	57.2 (2.25)		45 (1.77)
2GV150A~360A	63.5 (2.5)		50 (1.97)
3GV5A~25A	57.2 (2.25)	1/4-20 UNC	45 (1.77)
3GV30A~120A	63.5 (2.5)		50 (1.97)
3GV150A~360A	69.9 (2.75)		55 (2.17)
4GV5A~25A	63.5 (2.5)		48 (1.89)
4GV30A~120A	69.9 (2.75)		53 (2.09)
4GV150A~360A	76.2 (3)		58 (2.28)
5GV5A~18A, 5GVH5A~18A	69.9 (2.75)	5/16-18 UNC	52.5 (2.07)
5GV25A~100A, 5GVH25A~100A	82.6 (3.25)		65.5 (2.58)
5GV120A~300A, 5GVH120A~300A	88.9 (3.5)		71.5 (2.81)
5GVR5A~15A	69.9 (2.75)		52.5 (2.07)
5GVR18A~36A	82.6 (3.25)		65.5 (2.58)
5GVR50A~180A	95.3 (3.75)		77.5 (3.05)

- Installation screws: 4 flat washers, spring washers are included.
- Stainless steel screws are included.

● GN Gearheads, GE Gearheads

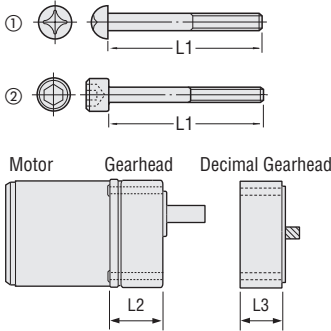

Product Name	Installation Screw			L2 mm (in.)	L2+L3 mm (in.)	
	L1 mm (in.)	Size	Drawing			
2GN35A~185A	50 (1.97)	No.8-32 UNC	①	37 (1.46)	—	
2GN255A~180SA	60 (2.36)			47 (1.85)	—	
3GN35A~185A	50 (1.97)	No.10-24 UNC		39 (1.54)	—	
3GN255A~180SA	65 (2.56)			49 (1.93)	—	
4GN35A~185A	50 (1.97)			39 (1.54)	—	
4GN255A~180SA	65 (2.56)	1/4-20 UNC		49.5 (1.95)	—	
5GN35A~185A	65 (2.56)			49.5 (1.95)	—	
5GN255A~180SA	80 (3.15)	67.5 (2.66)		—		
5GE□SA	95 (3.74)	M4 P0.7		②	72.5 (2.85)	—
2GN10XS (Decimal gearhead)	85 (3.35)			—	—	73 (2.87)
3GN10XS (Decimal gearhead)	90 (3.54)	M5 P0.8	①	—	79 (3.11)	
4GN10XS (Decimal gearhead)	95 (3.74)			—	—	81.5 (3.21)
5GN10XS (Decimal gearhead)	120 (4.72)	M6 P1.0	②	—	104.5 (4.11)	
5GE10XS (Decimal gearhead)	140 (5.51)			—	—	112.5 (4.43)

- Installation screws: 4 flat washers and hexagonal nuts are included.
- The values of L2+L3 refer to sizes when a decimal gearhead is connected with a gearhead of 25:1 or greater in gear ratio.

● BH Series

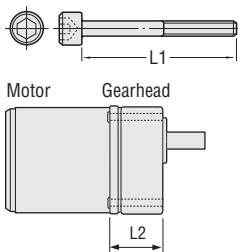

Product Name	Installation Screw		L2 mm (in.)
	L1 mm (in.)	Size	
BH162□-□, BH162□T-□	100 (3.94)	M8 P1.25	82.5 (3.25)

- Installation screws: 4 flat washers, spring washers and hexagonal nuts are included.
- Screws are not included with BH Series right-angle shaft combination type.

- **F, E or S** indicating the power supply voltage is entered where the box □ is located within the product name.
- A number indicating the gear ratio is entered where the box □ is located within the product name.

Overview,
Product
Series

Constant
Speed
Motors

Three-Phase
Induction
Motors

Single-Phase
Induction
Motors

Reversible
Motors

Electromagnetic
Brake Motors

Clutch &
Brake Motors

Low-Speed
Synchronous
Motors

Torque
Motors

Watertight,
Dust-Resistant
Motors

Right-Angle
Gearheads

Linear
Heads

Brake Pack

Accessories

Installation