

# Standard AC Motors

## Structure of Induction Motors

The following figure shows the structure of an induction motor.

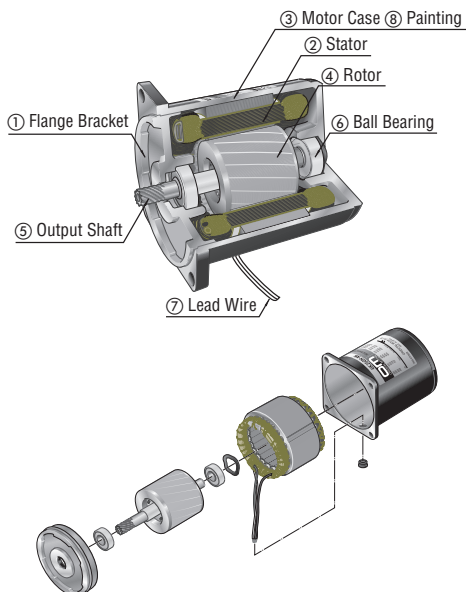

- ① Flange Bracket  
Made by cutting/finishing a die cast aluminum alloy block. It is press-fitted into the motor case.
- ② Stator  
Comprised of a stator core made from laminated magnetic steel sheets, windings made of polyester-sheathed copper wire, and insulation film.
- ③ Motor Case  
Made by cutting/finishing an aluminum alloy die cast block.
- ④ Rotor  
Comprised of laminated magnetic steel sheets and die cast aluminum alloy conductors.
- ⑤ Output Shaft  
A material such as S45C is used. There are also round shaft types and types that undergo precision gear finishing so they can be combined with a gearhead.
- ⑥ Ball Bearing
- ⑦ Lead Wires  
Lead wires with heat-resistant polyethylene sheathing.
- ⑧ Painting  
Baked finish of acrylic resin or melamine resin.

## Speed – Torque Characteristics of Induction Motors

The figure below shows the speed – torque characteristics of induction motors.

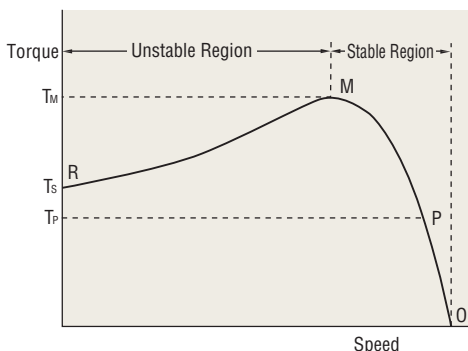

Under no load, the motor rotates at a speed close to synchronous speed. As the load increases, the motor's speed drops to a level (P) where a balance is achieved between load and motor torque ( $T_p$ ). If the load is further increased and reaches point M, the motor can generate no greater torque and stops at point R. In other words, the motor can be operated in a stable range between M and O, while the range between R and M is subject to instability.

Induction motors are available in two types: capacitor start and run single-phase induction motors and three-phase induction motors. With the single-phase motor, the starting torque is generally smaller than the operating torque. The three-phase motor features a relatively greater starting torque.

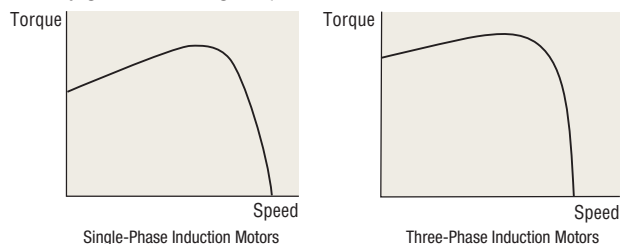

The torque the motor produces changes proportionally to roughly twice the power supply voltage. For example, if 110 VAC is applied to a motor whose rated voltage is 100 VAC, the torque produced by the motor increases to approximately 120%. In this case, the motor temperature will rise and may exceed the permissible range. If 90 VAC is applied to the same motor, the torque produced by the motor decreases to approximately 80%. In this case, the motor may not be able to operate the automated equipment as expected. For the above reasons, the power supply voltage should be kept within  $\pm 10\%$  of the rated voltage. Otherwise, when the power supply voltage fluctuates beyond the aforementioned range, the motor temperature may rise beyond the permissible range or the motor torque may drop and thereby make the equipment operation unstable.

## Structure of Reversible Motors

A reversible motor has a built-in friction brake mechanism (friction brake) at its rear. This mechanism is provided for the following purposes:

- To improve the instant reversing characteristics by adding a frictional load
- To reduce overrun

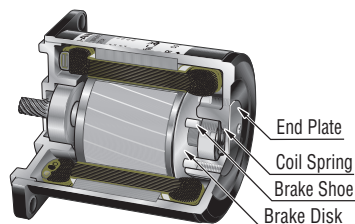

The brake mechanism is constructed as shown in the figure above. The coil spring applies constant pressure to allow the brake shoe to slide toward the brake plate. This mechanism provides a certain degree of holding brake force, but the force is limited due to the mechanism's structure, as described above. The brake force produced by the brake mechanism of a reversible motor is approximately 10% of the motor's output torque.

## Speed – Torque Characteristics of Reversible Motors

The reversible motor is a capacitor start and run, single-phase induction motor that features the same speed – torque characteristics as an induction motor, as described above. However, the reversible motor features a higher starting torque than an induction motor in order to improve the instant reversing characteristics.

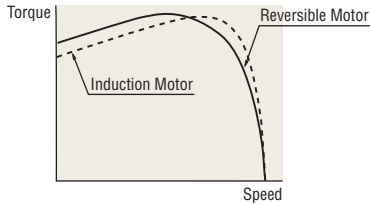

## Structure of an Electromagnetic Brake

An electromagnetic brake type motor is equipped with a power off activated type electromagnetic brake.

A representative example of an electromagnetic brake structure is shown below.

When voltage is applied to the magnet coil, the armature is attracted to the electromagnet against the force of the spring, thereby releasing the brake and allowing the motor shaft to rotate freely. When no voltage is applied, the spring works to press the armature onto the brake hub and hold the motor's shaft in place, thereby actuating the brake.

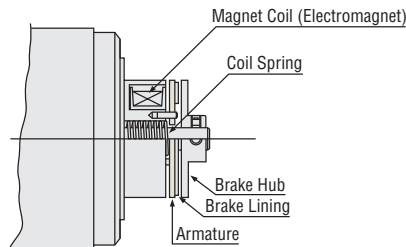

## Structure and Operation of Clutch and Brake Type Motors

The illustration to the right shows the structure of the clutch and brake type motor. When 24 VDC is not applied to either the clutch coil or brake coil, the output shaft can be rotated freely.



### ● Operation

When 24 VDC is applied to the clutch coil, the armature of the clutch coil is drawn against the clutch disk, transmitting motor rotation to the output shaft. The motor is constantly rotating.

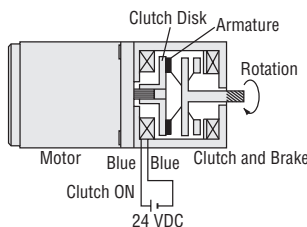

### ● Stopping and Load Holding

By turning the clutch coil excitation off after a certain time lag, applying 24 VDC to the brake coil will cause the armature on the brake to come into contact with the brake disk, which will cause the output shaft to come to a stop. During braking, the output shaft is released from the motor, so the inertia from the motor has no effect. The motor is constantly rotating.

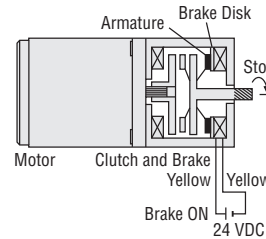

The figure below shows the relationship between the action of the motor shaft and output shaft and the state of excitation of the clutch and brake coils.

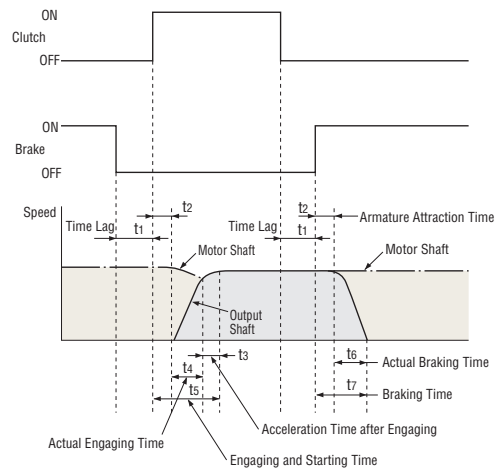

### ● Operation

When operation is shifted from holding the load to moving the load, a time lag of 20 ms or more is required after releasing the brake and before applying voltage to the clutch. (This is to prevent the clutch and brake from engaging at the same time.)

The time required for the clutch/brake output shaft to reach a constant speed after applying voltage to the clutch is referred to as the engaging and starting time ( $t_5$ ) and is calculated by adding up the following time elements:

- ① Armature Attraction Time  $t_2$   
The time required for the armature to come into contact with the clutch after voltage application to the clutch.
- ② Actual Engaging Time  $t_4$   
The time required for the clutch/brake output shaft, which is accelerated by dynamic friction torque, to engage completely with the motor shaft after the armature comes in contact with the clutch.
- ③ Acceleration Time after Engaging  $t_5$   
The time needed to accelerate to the required speed when load is suddenly applied to the motor during the actual engaging time described in ②, causing a temporary drop in speed.

### ● Braking

When the operational status is shifted from rotation to stopping or holding a load, a time lag of 20 ms or more is required after releasing the clutch and before applying voltage to the brake. The time required for the clutch/brake output shaft to come to a stop after applying voltage to the brake is referred to as the braking time ( $t_7$ ) and is calculated by adding up the following time elements:

- ① Armature Attraction Time  $t_2$   
The time required for the armature to contact with the brake plate after voltage application to the brake.
- ② Actual Braking Time  $t_6$   
The time required for rotation of the clutch/brake output shaft to come to a stop after the armature comes into contact with the brake plate.

Selection Calculations

Motors

Linear & Rotary Actuators

Cooling Fans

Service Life

Stepper Motors

Servo Motors

Standard AC Motors

Brushless Motors/AC Speed Control Motors

Gearheads

Cooling Fans

● Engaging and Starting Characteristics (Reference value)

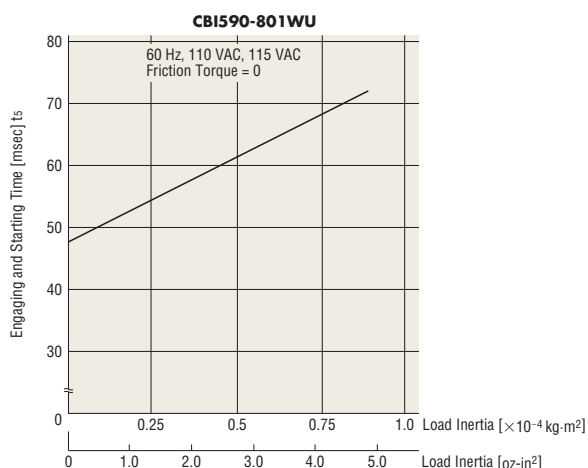

● Braking Characteristics (Reference value)

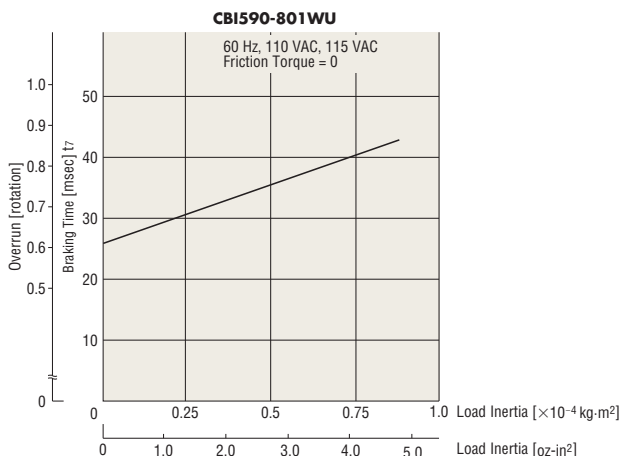

■ Overheat Protection Device

If a motor operating in run mode locks due to overload, the ambient temperature rises rapidly, or the input current increases for some reason, the motor's temperature rises abruptly. If the motor is left in this state, the insulating performance within the motor may deteriorate, reducing its life and, in extreme cases, scorching the winding and causing a fire. In order to protect the motor from such thermal abnormalities, our motors are recognized by UL and CSA Standards, conform to EN and IEC Standards and are equipped with the following overheat protection device.

● Thermal Protector

Motors with a frame size of 70 mm (2.76 in.), 80 mm (3.15 in.), 90 mm (3.54 in.) or 104 mm (4.09 in.) square contain a built-in automatic return type thermal protector. \*

The structure of a thermal protector is shown in the figure below.

\*The **KIIS** Series doesn't have a built-in overheat protection device (thermal protector), so an electromagnetic switch or the electrothermal function of an inverter must be used.

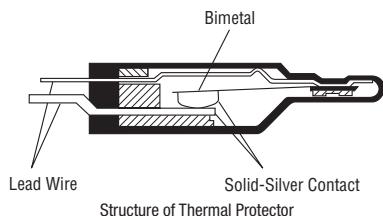

The thermal protector employs a bimetal system in which solid silver is used in the contacts. Solid silver has the lowest electrical resistance of all metals and has the second highest heat conduction second only to copper.

◇ Operating Temperature of Thermal Protector

Open:  $130 \pm 5^{\circ}\text{C}$  ( $266 \pm 9^{\circ}\text{F}$ )  
(the operating temperature varies depending on the motor type)  
Closed:  $82 \pm 15^{\circ}\text{C}$  ( $179.6 \pm 27^{\circ}\text{F}$ )  
(the operating temperature varies depending on the motor type)  
(The motor winding temperature, where the thermal protector is activated, is slightly higher than the operating temperature listed above.)

● Impedance Protected Motors

Motors with a frame size of 60 mm (2.36 in.) square or less are equipped with impedance protection. Impedance protected motors are designed with higher impedance in the motor windings so that even if the motor locks, the increase in current (input) will be minimized and temperature will not rise above a certain level.

For the overheat protection functions available with each product, refer to the page explaining the product.

■ Capacitor

Oriental Motor's AC motors designed for a single-phase power supply are all capacitor start and run motors. Capacitor start and run motors contain an auxiliary winding offset by 90 electrical degrees from the main winding. The capacitor is connected in series with the auxiliary winding, causing the advance of current phase in the auxiliary winding.

Motors employ vapor-deposition electrode capacitors recognized by UL. This type of capacitor, which uses a metallized paper or plastic film as an element, is also known as a "self-healing (SH) capacitor" because of the self-healing property of the capacitor element. Although most of the previous capacitors used paper elements, the plastic film capacitor has become a mainstream model in recent years due to the growing demand for compact design.

● Film capacitor, square resin case type  
(Oriental Motor Product Name: CH capacitor)

● Capacitance

The use of a capacitor with a different capacitance may cause excessive motor vibration and heat generation or may result in torque drops and unstable operation. Be sure to use the capacitor included with the motor. The capacitor's capacitance is expressed in microfarads ( $\mu\text{F}$ ).

● Rated Voltage

Using a capacitor exceeding the rated voltage may cause damage and the capacitor may smoke or ignite. Be sure to use the capacitor included with the motor. The rated voltage of the capacitor is expressed in volts (V). The capacitor's rated voltage is indicated on the surface of the capacitor case. Take proper precautions, since the capacitor's rated voltage is different from that of the motor.

● Rated Conduction Time

The rated conduction time is the minimum design life of the capacitor when operated at the rated load, rated voltage, rated temperature and rated frequency. The standard life expectancy is 25,000 hours. A capacitor that breaks at the end of its life expectancy may smoke or ignite. We recommend that the capacitor be replaced after the rated conduction time.

Consider providing a separate protection measure to prevent the equipment from being negatively influenced in the event of capacitor failure.

● Safety Feature of Capacitor

Some capacitors are equipped with a safety feature that allows for safe and complete removal of the capacitor from circuits to prevent smoke and/or fire in the event of a dielectric breakdown. Oriental Motor products use capacitors with UL recognized safety features that have passed the UL 810 requirement of a 10,000 A fault current test.