

High-Torque 2-Phase Stepper Motors

PKP Series with PLE Gearhead

High-Torque Combination
Bipolar 2-phase Stepper Motors
with Neugart Planetary Gearheads

Short Delivery Time



Planetary
Gearheads

2-Phase Stepper Motors PKP Series

● For detailed information about regulations and standards, please refer to the Oriental Motor website.



These products are high-torque 2-phase stepper motors. A wide variety of products are available to meet your design specifications.

- Standard Type with a Resolution of 200 Steps per Revolution (Basic step angle: 1.8°/step)
- Bipolar (4 lead wires)
- Encoder Types are Available
- Many Motor Current Models are Available



See Full Product Details Online
www.orientalmotor.com

● Manual

● Specifications

● Dimensions

● CAD

● Characteristics

● Connection and Operation

Features

Increased Torque over the Entire Speed Range from Low to High

After revising the magnetic and structure design of the **PKP** Series, it produces much more torque than the standard **PK** Series motors of the same size. In addition, torque can be increased in the high-speed range by using high current motors.

Comparison of Speed – Torque Characteristics of the Same Size Motors

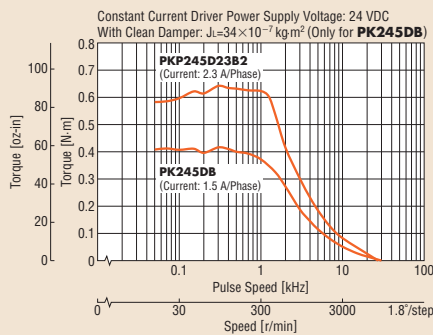

High current is possible due to the revised motor winding design and the highly efficient design of the drive circuit that can be combined. Increased torque over the entire speed range from low to high is achieved.

Comparison of Maximum Holding Torque

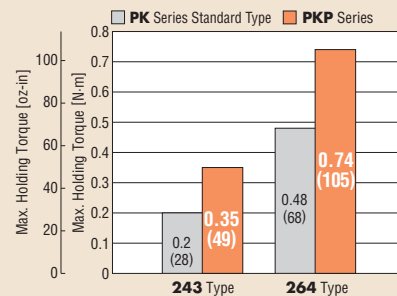

Compact and Flat Connector

The **PKP** Series uses a compact and flat connector, which shortens the length of the connector's overhang. In addition, the degree of freedom for the cable outlet direction has been increased, because the outlet direction points upward.

● Because the connector is provided for some products only, refer to dimensions of each model for details.

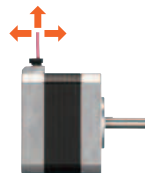

Lower Vibration

Revising the magnetic design has achieved lower vibration compared to conventional products.

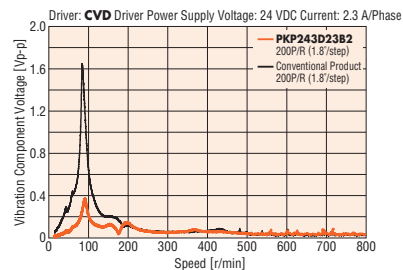

Features of the PLE Planetary Gearhead

The **PLE** Series from Neugart is notably light, extremely powerful, yet suitable for complex production cycles due to its low-friction bearing design and optimized lubrication.

- **Light & Powerful**

The **PLE** excels with its above-average weight to torque ratio, and it is 25% lighter than comparable conventional gearheads.

- **Efficient and Reliable**

With the innovative design, low backlash with high output torque is achieved.

- **Low Heat Generation**

Low-friction bearing design and optimized lubrication allows for continuous operation without sacrificing performance

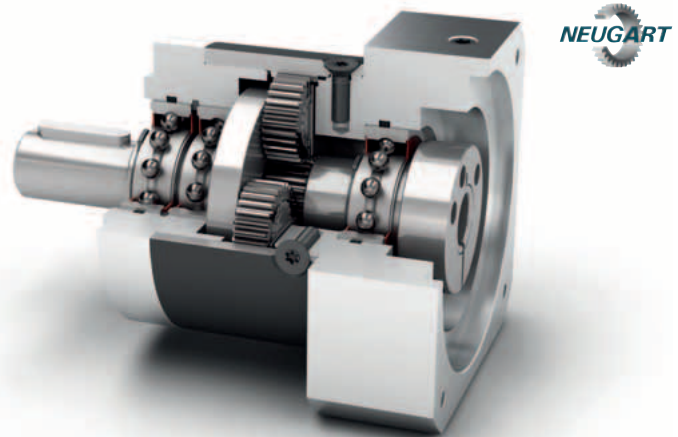

Downsizing is Possible!

Use a **PKP** Series motor with **PLE** gearhead in place of a standard motor from the **PK** series motor with **PL** gearhead with the equivalent torque in order to downsize motors.

- Comparison of Torque Characteristics of **PKP246D23A2-PLE40-10** and **PK266PDA-P10**

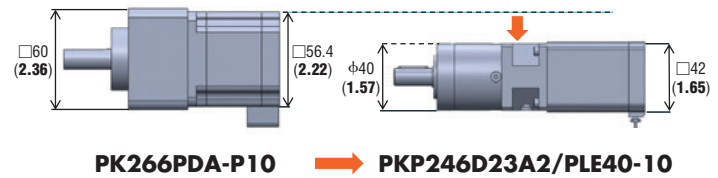
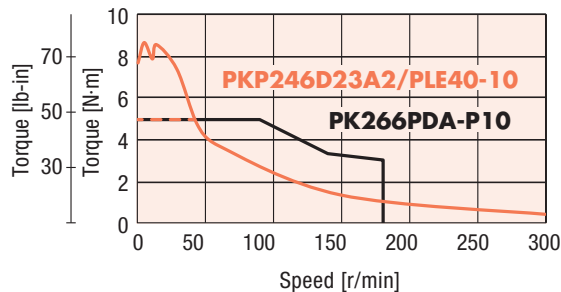

Product Line Equipped with Encoder

- **With Encoder**

(Provided for standard type)

Encoder Specifications → Page 25

- **Main Specifications**

Type	Standard Type	High-Resolution Type
Resolution	200 P/R, 400 P/R	400 P/R
Output Signal	A Phase, B Phase, Z Phase (3ch)	



- ◇ **Equipped with a Compact Encoder**

- When frame size is 42 mm (1.65 in.)

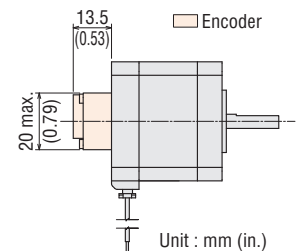

- ◇ **Motor Position Detection is Possible**

Monitoring the current position and detecting positional errors is possible. For example, comparing the command position and current position enables you to check the normal operation of the motor.

- ◇ **High Reliability with Line Driver Output Circuit Type**

Noise resistance is improved by differential output, and the wiring distance can be longer than with the voltage output type.

Bipolar Driver for 2-Phase Stepper Motors

● For detailed information about regulations and standards, please refer to the Oriental Motor website.

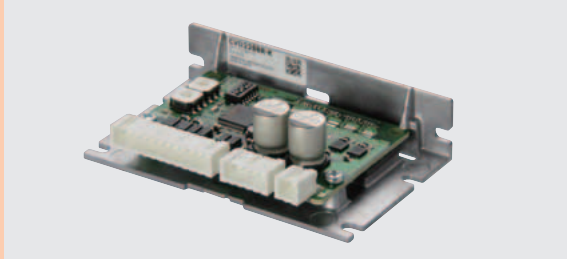

- This is a DC power supply input driver for bipolar 2-phase stepper motors.
- Using this microstepping driver reduces vibration and noise.



See Full Product Details Online
www.orientalmotor.com

● Manual

● Specifications

● Dimensions

● CAD

● Characteristics

● Connection and Operation

Features and Types

● Bipolar Driver

Driver Type	External View	Introduction	Driver Installation Direction
<ul style="list-style-type: none"> ● Bipolar Driver for 2-Phase Stepper Motors ● Driver for 5-Phase Stepper Motors <p>52.5 mm (2.07 in.)</p> <p>24.5 mm (0.96 in.)</p> <p>85 mm (3.35 in.)</p> <ul style="list-style-type: none"> • Mass 20 g (0.71 oz.)~70 g (2.47 oz.) (The value differs according to the driver type.) ● The driver cannot be shared by both a 2-Phase stepper motors and 5-Phase stepper motors. Each must use its respective dedicated driver. 	<p>The connector points outward.</p>	<ul style="list-style-type: none"> • Compact and lightweight driver with full-time microstepping. • Using the smooth drive function reduces the vibration and noise more than conventional products. 	<ul style="list-style-type: none"> • Horizontal installation • Vertical installation
<p>Without Installation Plate</p>	<p>The connector points upward.</p>	<ul style="list-style-type: none"> • The driver is equipped with a protective function that enables you to find driver errors early. • Run current can be easily set with the digital switch. 	

● See back cover for pricing and details.

● Additional Product Line

◇ Bipolar CVD-S Type for 2-Phase Stepper Motors



This is a compact board mounting type driver.

- I/O Setting Type
- SPI communications Type

For details, please contact the nearest Oriental Motor sales office.

◇ CVK Series SC Type Driver (Used with 5-phase Stepper Motors)

This driver allows the stepper motors to operate like a speed control motor. It can be operated easily by using the forward and reverse inputs only.

- No Pulse Generator Required
- Available for Setting in Two Speeds
- Compact and High-Torque
- Enhanced Repeatability of the Stop Position
- Possible to Hold the Load at Standstill
- 100% Duty cycle

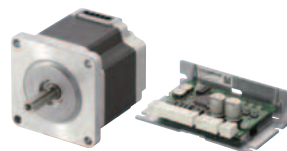

For details, please contact the nearest Oriental Motor sales office or visit our website.

System Configuration

These accessories allow the 1.8° Stepper Motor **PKP** Series to be used for various operations. An example of a system configuration with the **SCX11** controller is shown below.

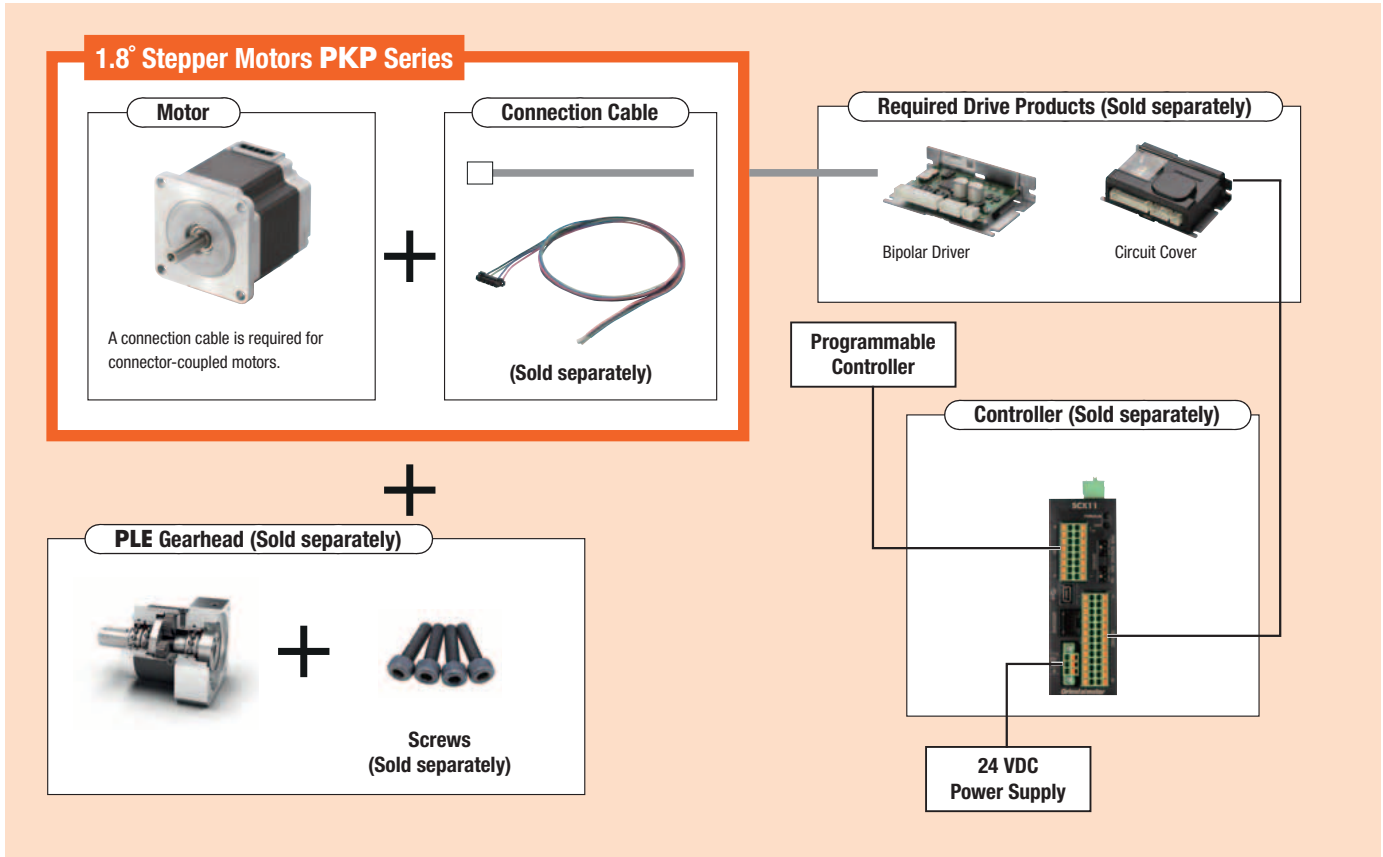

Example of System Configuration

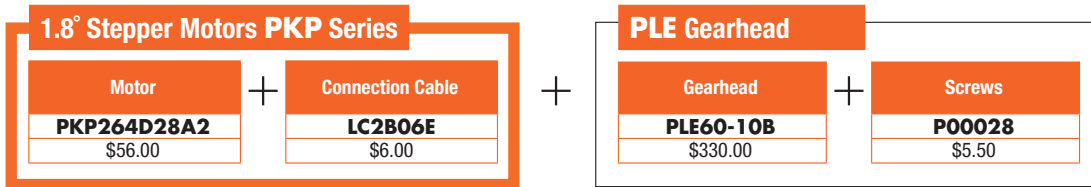

The system configuration shown above is an example. Other combinations are also available.

Product Number

Motor

PKP Series

Standard Type

PKP 2 6 4 D 28 A A 2

① ② ③ ④ ⑥ ⑦ ⑧ ⑨ ⑩

Standard Type with Encoder

PKP 2 4 3 D 15 A 2 - R2F L

① ② ③ ④ ⑥ ⑦ ⑧ ⑨ ⑩ ⑪

①	Series Name	PKP: PKP Series	
②	2: 2-Phase		
③	Motor Frame Size	1: 20 mm (0.79 in.) 2: 28 mm (1.10 in.) 3: 35 mm (1.38 in.) 4: 42 mm (1.65 in.) 6: 56.4 mm (2.22 in.)	
④	Motor Case Length		
⑤	Motor Type	Blank: Standard Type	
⑥	Number of Lead Wires	D: 4 Leads U: 5 or 6 Leads	
⑦	Motor Winding Specifications		
⑧	Configuration	A: Single Shaft	
⑨	Reference Number		
⑩	Encoder Resolution	R2E: 200 P/R R2F: 400 P/R	
⑪	Encoder Output Circuit Type	L: Line Driver Output*	

*A voltage output type of encoder output circuit is also available. For details, please contact your nearest Oriental Motor sales office.

PLE Gearhead

PLE 40 - 5 B

① ② ③ ④

①	Gear Type:	PLE: PLE Series
②	Gear Size:	40: 42 mm (1.65 in.), 60: 56.4 mm (2.22 in.) 80: 85 mm (3.35 in.)
③	Gear Ratio:	5:1, 10:1, 20:1, 40:1
④	Input Coupling:	D: D Inch, B Metric

①	Series Name	PKP: PKP Series	
②	2: 2-Phase		
③	Motor Frame Size	4: 42 mm (1.65 in.) 6: 56.4 mm (2.22 in.) 9: 85 mm (3.35 in.)	
④	Motor Case Length		
⑤	Motor Type	Blank: Standard Type	
⑥	Number of Lead Wires	D: 4 Leads	
⑦	Motor Winding Specifications		
⑧	Configuration	A: Single Shaft B: Double Shaft	
⑨	Output Shaft Diameter	A: Imperial Blank: Metric	
⑩	Reference Number		

Connection cable

Connection Cable for Motor

LC 2 B 06 A

① ② ③ ④ ⑤

①	Cables	LC: Connector Leads
②	2: 2-Phase	
③	Cable Type	B: Bipolar U: Unipolar
④	Cable Length	06: 0.6 m (2 ft.) 10: 1 m (3.3 ft.)
⑤	Reference Number	

Connection Cable for Encoder

LC E 08 A - 006

① ② ③ ④ ⑤

①	Cables	LC: Connector Leads
②	Cable Type	E: Encoder
③	Applicable Models	05: Voltage Output 08: Line Driver Output
④	Reference Number	
⑤	Cable Length	006: 0.6 m (2 ft.)

Screws

P000 27

① ②

①	Screw Set:	PLE: PLE Series
②	Screw Length	27: 42 mm (1.65 in.), 28: 56.4 mm (2.22 in.) 29: 85 mm (3.35 in.)

Product Line

A connector-coupled motor requires a connection cable.
Motors and connection cables must be ordered separately.

● Motor

◇ Standard Type, Standard Type with Encoder

● Bipolar

Product Name (Single Shaft)	List Price	Product Name (Double Shaft)	List Price
PKP243D15A2	\$45.00	PKP243D15B2	\$47.00
PKP243D23A2	\$45.00	PKP243D23B2	\$47.00
PKP244D08A2	\$47.00	PKP244D08B2	\$49.00
PKP244D15A2	\$47.00	PKP244D15B2	\$49.00
PKP244D23A2	\$47.00	PKP244D23B2	\$49.00
PKP245D08A2	\$53.00	PKP245D08B2	\$55.00
PKP245D15A2	\$53.00	PKP245D15B2	\$55.00
PKP245D23A2	\$53.00	PKP245D23B2	\$55.00
PKP246D15A2	\$56.00	PKP246D15B2	\$58.00
PKP246D23A2	\$56.00	PKP246D23B2	\$58.00
PKP264D14A2	\$56.00	PKP264D14B2	\$58.00
PKP264D28A2	\$56.00	PKP264D28B2	\$58.00
PKP264D42A2	\$56.00	PKP264D42B2	\$58.00
PKP266D14A2	\$62.00	PKP266D14B2	\$64.00
PKP266D28A2	\$62.00	PKP266D28B2	\$64.00
PKP266D42A2	\$62.00	PKP266D42B2	\$64.00
PKP268D14A2	\$76.00	PKP268D14B2	\$79.00
PKP268D28A2	\$76.00	PKP268D28B2	\$79.00
PKP268D42A2	\$76.00	PKP268D42B2	\$79.00
PKP296D45A	\$108.00	PKP296D45B	\$112.00
PKP296D63A	\$108.00	PKP296D63B	\$112.00
PKP299D45A	\$165.00	PKP299D45B	\$171.00
PKP299D63A	\$165.00	PKP299D63B	\$171.00
PKP2913D45A	\$209.00	PKP2913D45B	\$218.00
PKP2913D56A	\$209.00	PKP2913D56B	\$218.00

● Connection Cable

◇ Motor Cable (For bipolar)

Product Name	Length m (ft.)	List Price
LC2B06A	0.6 (2)	\$5.00
LC2B06B	0.6 (2)	\$5.00
LC2B06C	0.6 (2)	\$5.00
LC2B06E	0.6 (2)	\$6.00

◇ Encoder Cable

Product Name	Length m (ft.)	List Price
LCE05A-006	0.6 (2)	\$11.00
LCE08A-006	0.6 (2)	\$11.00

● PLE Gearhead

◇ Metric (motor shaft)

Product Name	List Price
PLE40-5B	\$274.00
PLE40-10B	\$274.00
PLE40-20B	\$331.00
PLE40-40B	\$331.00
PLE60-5B	\$330.00
PLE60-10B	\$330.00
PLE60-20B	\$409.00
PLE60-40B	\$409.00
PLE80-5B	\$409.00
PLE80-10B	\$409.00
PLE80-20B	\$545.00
PLE80-40B	\$545.00

◇ Inch (motor shaft)

Product Name	List Price
–	–
–	–
–	–
–	–
–	–
PLE60-5D	\$330.00
PLE60-10D	\$330.00
PLE60-20D	\$409.00
PLE60-40D	\$409.00
PLE80-5D	\$409.00
PLE80-10D	\$409.00
PLE80-20D	\$545.00
PLE80-40D	\$545.00

● Bipolar with Encoder

Product Name (Voltage)	List Price	Product Name (Line Driver)	List Price
PKP243D15A2-R2E	\$104.00	PKP243D15A2-R2EL	\$104.00
PKP243D15A2-R2F	\$104.00	PKP243D15A2-R2FL	\$104.00
PKP243D23A2-R2E	\$104.00	PKP243D23A2-R2EL	\$104.00
PKP243D23A2-R2F	\$104.00	PKP243D23A2-R2FL	\$104.00
PKP244D15A2-R2E	\$106.00	PKP244D15A2-R2EL	\$106.00
PKP244D15A2-R2F	\$106.00	PKP244D15A2-R2FL	\$106.00
PKP244D23A2-R2E	\$106.00	PKP244D23A2-R2EL	\$106.00
PKP244D23A2-R2F	\$106.00	PKP244D23A2-R2FL	\$106.00
PKP245D15A2-R2E	\$113.00	PKP245D15A2-R2EL	\$113.00
PKP245D15A2-R2F	\$113.00	PKP245D15A2-R2FL	\$113.00
PKP245D23A2-R2E	\$113.00	PKP245D23A2-R2EL	\$113.00
PKP245D23A2-R2F	\$113.00	PKP245D23A2-R2FL	\$113.00
PKP246D15A2-R2E	\$115.00	PKP246D15A2-R2EL	\$115.00
PKP246D15A2-R2F	\$115.00	PKP246D15A2-R2FL	\$115.00
PKP246D23A2-R2E	\$115.00	PKP246D23A2-R2EL	\$115.00
PKP246D23A2-R2F	\$115.00	PKP246D23A2-R2FL	\$115.00
PKP264D14A2-R2E	\$115.00	PKP264D14A2-R2EL	\$115.00
PKP264D14A2-R2F	\$115.00	PKP264D14A2-R2FL	\$115.00
PKP264D28A2-R2E	\$115.00	PKP264D28A2-R2EL	\$115.00
PKP264D28A2-R2F	\$115.00	PKP264D28A2-R2FL	\$115.00
PKP264D42A2-R2E	\$115.00	PKP264D42A2-R2EL	\$115.00
PKP264D42A2-R2F	\$115.00	PKP264D42A2-R2FL	\$115.00
PKP266D14A2-R2E	\$121.00	PKP266D14A2-R2EL	\$121.00
PKP266D14A2-R2F	\$121.00	PKP266D14A2-R2FL	\$121.00
PKP266D28A2-R2E	\$121.00	PKP266D28A2-R2EL	\$121.00
PKP266D28A2-R2F	\$121.00	PKP266D28A2-R2FL	\$121.00
PKP266D42A2-R2E	\$121.00	PKP266D42A2-R2EL	\$121.00
PKP266D42A2-R2F	\$121.00	PKP266D42A2-R2FL	\$121.00
PKP268D14A2-R2E	\$138.00	PKP268D14A2-R2EL	\$138.00
PKP268D14A2-R2F	\$138.00	PKP268D14A2-R2FL	\$138.00
PKP268D28A2-R2E	\$138.00	PKP268D28A2-R2EL	\$138.00
PKP268D28A2-R2F	\$138.00	PKP268D28A2-R2FL	\$138.00
PKP268D42A2-R2E	\$138.00	PKP268D42A2-R2EL	\$138.00
PKP268D42A2-R2F	\$138.00	PKP268D42A2-R2FL	\$138.00

*All PKP26_type encoder motors come with 8 mm output shaft.

See drawings for details, page 18.

● Screws

Product Name	List Price
P00027	\$5.50
P00028	\$5.50
P00029	\$5.50

Standard Type Standard Type with Encoder

Frame Size 42 mm (1.65 in.) Bipolar 4 Lead Wires

Specifications

Product Name	Maximum Holding Torque	Rotor Inertia J: kg·m ² (oz·in ²)	Rated Current	Voltage	Winding Resistance	Inductance	Basic Step Angle	Recommended Driver Product Name*
	N·m (oz·in)		A/Phase	VDC	Ω/Phase	mH/Phase		
PKP243D15□2	0.35 (49)	36×10 ⁻⁷ (0.197)	1.5	2.7	1.8	3.3	1.8°	CVD215BR-K
PKP243D23□2			2.3	1.8	0.78	1.4		CVD223FBR-K
PKP244D15□2	0.48 (68)	54×10 ⁻⁷ (0.3)	1.5	3.2	2.1	4.4		CVD215BR-K
PKP244D23□2			2.3	2.1	0.93	1.9		CVD223FBR-K
PKP245D15□2	0.66 (93)	73×10 ⁻⁷ (0.4)	1.5	3.3	2.2	5.3		CVD215BR-K
PKP245D23□2			2.3	2.3	1	2.2		CVD223FBR-K
PKP246D15□2	0.99 (140)	110×10 ⁻⁷ (0.6)	1.5	4.4	2.9	7.9		CVD215BR-K
PKP246D23□2			2.3	3.2	1.4	3.3		CVD223FBR-K
PKP243D15A2-R2	0.35 (49)	36×10 ⁻⁷ (0.2)	1.5	2.7	1.8	3.3		CVD215BR-K
PKP243D23A2-R2			2.3	1.8	0.78	1.4		CVD223FBR-K
PKP244D15A2-R2	0.48 (68)	54×10 ⁻⁷ (0.3)	1.5	3.2	2.1	4.4		CVD215BR-K
PKP244D23A2-R2			2.3	2.1	0.93	1.9		CVD223FBR-K
PKP245D15A2-R2	0.66 (93)	73×10 ⁻⁷ (0.4)	1.5	3.3	2.2	5.3		CVD215BR-K
PKP245D23A2-R2			2.3	2.3	1	2.2		CVD223FBR-K
PKP246D15A2-R2	0.99 (140)	110×10 ⁻⁷ (0.6)	1.5	4.4	2.9	7.9		CVD215BR-K
PKP246D23A2-R2			2.3	3.2	1.4	3.3		CVD223FBR-K

● The box □ in the product name indicates the shaft **A** (single shaft) or **B** (double shaft).

The box □ in the product name indicates the encoder resolution **E** (200 P/R) or **F** (400 P/R).

The box ■ in the product name indicates the encoder output circuit type **L** (line driver output). The voltage output type will have no "■" in the product name.

● See page 25 for encoder specifications.

PLE40 Gearhead Specifications for Metric Motor Shaft

Gear Head Product Name	Base Motor	Gear Ratio	Holding Torque	Basic Step Angle	Permissible Torque	Maximum Torque	Backlash arcmin	Speed Range
			N·m (lb·in)	deg/step	N·m (lb·in)	N·m (lb·in)		0~ (r/min)
PLE40-5B	PKP243D15□□	5	1.57 (14)	0.36	*	*	15	500
PLE40-10B	PKP243D15□□	10	3.15 (28)	0.18	*	*		250
PLE40-20B	PKP243D15□□	20	6.3 (56)	0.09	*	*	19	125
PLE40-40B	PKP243D15□□	40	12.6 (112)	0.045	*	*		62.5
PLE40-5B	PKP243D23□□	5	1.575 (14)	0.36	*	*	15	600
PLE40-10B	PKP243D23□□	10	3.15 (28)	0.18	*	*		300
PLE40-20B	PKP243D23□□	20	6.3 (56)	0.09	*	*	19	150
PLE40-40B	PKP243D23□□	40	12.6 (112)	0.045	*	*		75
PLE40-5B	PKP244D15□□	5	2.16 (19)	0.36	*	*	15	400
PLE40-10B	PKP244D15□□	10	4.32 (38)	0.18	*	*		200
PLE40-20B	PKP244D15□□	20	8.64 (76)	0.09	*	*	19	100
PLE40-40B	PKP244D15□□	40	17.28 (153)	0.045	*	*		50
PLE40-5B	PKP244D23□□	5	2.16 (19)	0.36	*	*	15	500
PLE40-10B	PKP244D23□□	10	4.32 (38)	0.18	*	*		250
PLE40-20B	PKP244D23□□	20	8.64 (76)	0.09	*	*	19	125
PLE40-40B	PKP244D23□□	40	17.28 (163)	0.045	*	*		62.5
PLE40-5B	PKP245D15□□	5	2.97 (26)	0.36	*	*	15	300
PLE40-10B	PKP245D15□□	10	5 (44)	0.18	5 (44)	*		150
PLE40-20B	PKP245D15□□	20	11.88 (105)	0.09	*	*	19	75
PLE40-40B	PKP245D15□□	40	18 (159)	0.045	18 (159)	*		37.5
PLE40-5B	PKP245D23□□	5	2.97 (26)	0.36	*	*	15	400
PLE40-10B	PKP245D23□□	10	5 (44)	0.18	5 (44)	*		200
PLE40-20B	PKP245D23□□	20	11.88 (105)	0.09	*	*	19	100
PLE40-40B	PKP245D23□□	40	18 (159)	0.045	18 (159)	*		50
PLE40-5B	PKP246D15□□	5	4.455 (39)	0.36	*	*	15	200
PLE40-10B	PKP246D15□□	10	5 (44)	0.18	5 (44)	8 (71)		100
PLE40-20B	PKP246D15□□	20	17.82 (158)	0.09	*	*	19	50
PLE40-40B	PKP246D15□□	40	18 (159)	0.045	18 (159)	29 (257)		25
PLE40-5B	PKP246D23□□	5	4.455 (39)	0.36	*	*	15	300
PLE40-10B	PKP246D23□□	10	5 (44)	0.18	5 (44)	8 (71)		150
PLE40-20B	PKP246D23□□	20	17.82 (158)	0.09	*	*	19	75
PLE40-40B	PKP246D23□□	40	18 (159)	0.045	18 (159)	29 (257)		37.5

*Torque does not reach the permissible output of the PLE Gearhead

● Use screw set **P00027** (sold separately) to attach Motor and Gearhead

Speed – Torque Characteristics (Reference Values)

◇ PKP243D15/PLE40

PKP243D15 Gear Ratio 5

Driver: CVD223FBR-K, Power Supply Voltage: 24 VDC, Current: 1.5 A/Phase

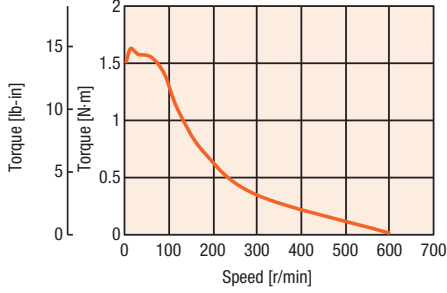

◇ PKP243D23/PLE40

PKP243D23 Gear Ratio 5

Driver: CVD223FBR-K, Power Supply Voltage: 24 VDC, Current: 2.3 A/Phase

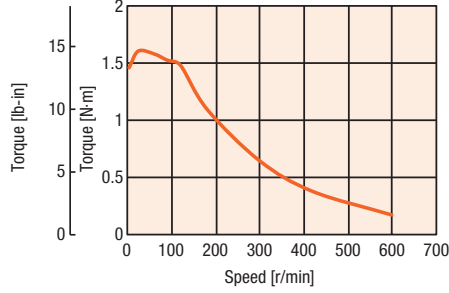

◇ PKP244D15/PLE40

PKP244D15 Gear Ratio 5

Driver: CVD223FBR-K, Power Supply Voltage: 24 VDC, Current: 1.5 A/Phase

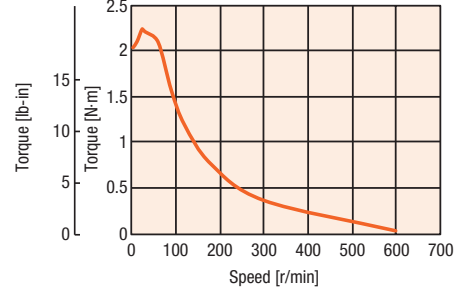

PKP243D15 Gear Ratio 10

Driver: CVD223FBR-K, Power Supply Voltage: 24 VDC, Current: 1.5 A/Phase

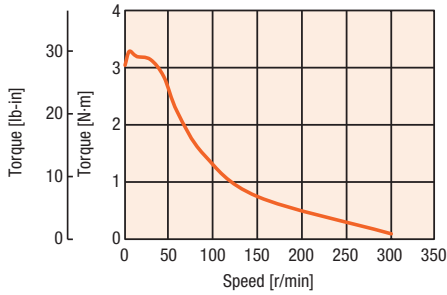

PKP243D23 Gear Ratio 10

Driver: CVD223FBR-K, Power Supply Voltage: 24 VDC, Current: 2.3 A/Phase

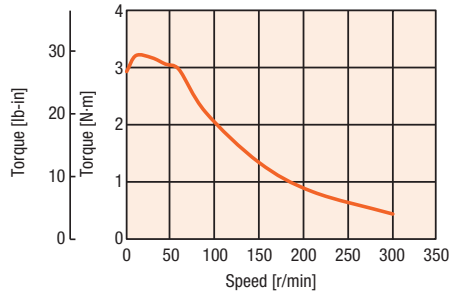

PKP244D15 Gear Ratio 10

Driver: CVD223FBR-K, Power Supply Voltage: 24 VDC, Current: 1.5 A/Phase

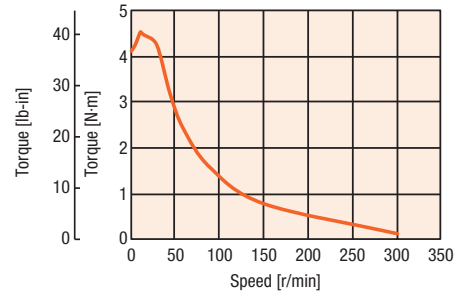

PKP243D15 Gear Ratio 20

Driver: CVD223FBR-K, Power Supply Voltage: 24 VDC, Current: 1.5 A/Phase

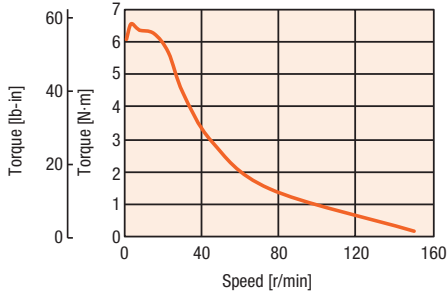

PKP243D23 Gear Ratio 20

Driver: CVD223FBR-K, Power Supply Voltage: 24 VDC, Current: 2.3 A/Phase

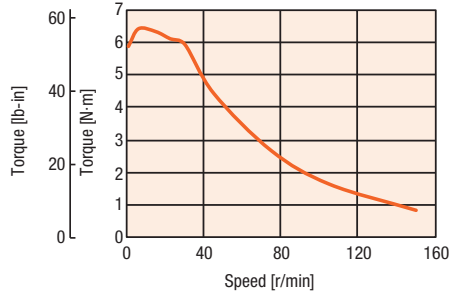

PKP244D15 Gear Ratio 20

Driver: CVD223FBR-K, Power Supply Voltage: 24 VDC, Current: 1.5 A/Phase

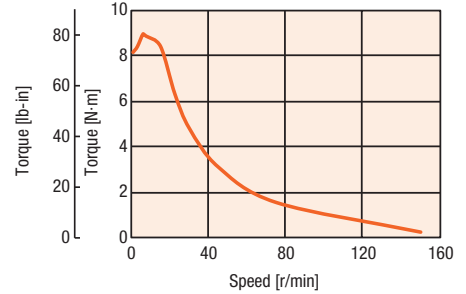

PKP243D15 Gear Ratio 40

Driver: CVD223FBR-K, Power Supply Voltage: 24 VDC, Current: 1.5 A/Phase

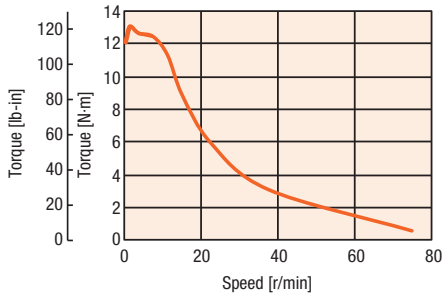

PKP243D23 Gear Ratio 40

Driver: CVD223FBR-K, Power Supply Voltage: 24 VDC, Current: 2.3 A/Phase

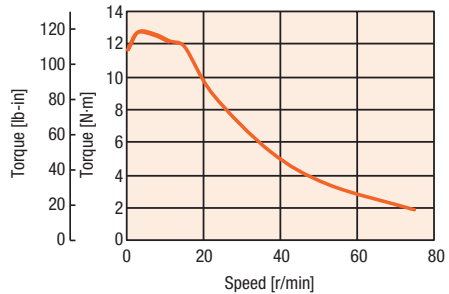

PKP244D15 Gear Ratio 40

Driver: CVD223FBR-K, Power Supply Voltage: 24 VDC, Current: 1.5 A/Phase

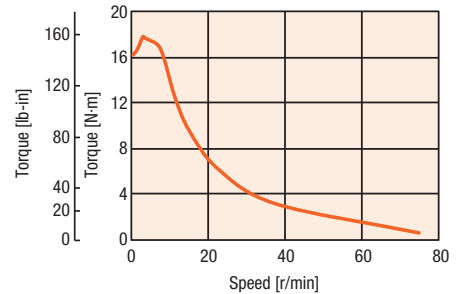

- Data for the speed-torque characteristics is based on Oriental Motor's internal conditions. If the conditions are changed, the characteristics may also change as a result.
- Depending on the driving conditions, a considerable amount of heat may be generated by the motor. Be sure to keep the motor case temperature at 100°C (212°F) or less. In case of product with encoder, be sure to keep the motor case temperature at 85°C (185°F) max. to protect the encoder.

◇ PKP244D23/PLE40

PKP244D23 Gear Ratio 5

Driver: CVD223FBR-K, Power Supply Voltage: 24 VDC, Current: 2.3 A/Phase

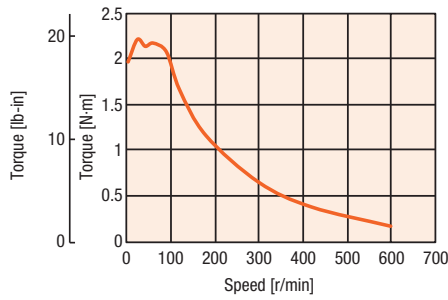

◇ PKP245D15/PLE40

PKP245D15 Gear Ratio 5

Driver: CVD223FBR-K, Power Supply Voltage: 24 VDC, Current: 1.5 A/Phase

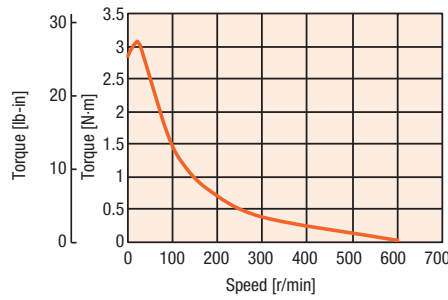

◇ PKP245D23/PLE40

PKP245D23 Gear Ratio 5

Driver: CVD223FBR-K, Power Supply Voltage: 24 VDC, Current: 2.3 A/Phase

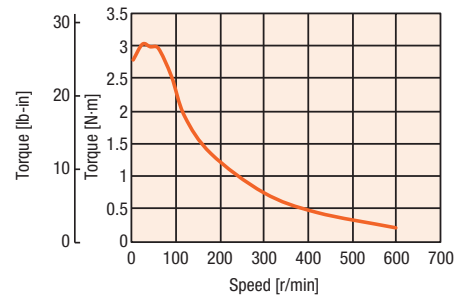

PKP244D23 Gear Ratio 10

Driver: CVD223FBR-K, Power Supply Voltage: 24 VDC, Current: 2.3 A/Phase

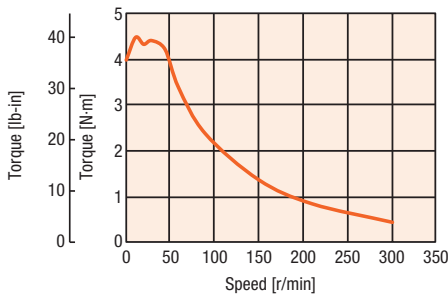

PKP245D15 Gear Ratio 10

Driver: CVD223FBR-K, Power Supply Voltage: 24 VDC, Current: 1.5 A/Phase

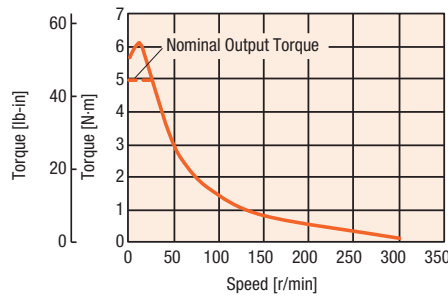

PKP245D23 Gear Ratio 10

Driver: CVD223FBR-K, Power Supply Voltage: 24 VDC, Current: 2.3 A/Phase

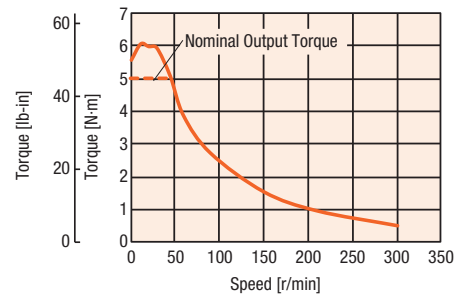

PKP244D23 Gear Ratio 20

Driver: CVD223FBR-K, Power Supply Voltage: 24 VDC, Current: 2.3 A/Phase

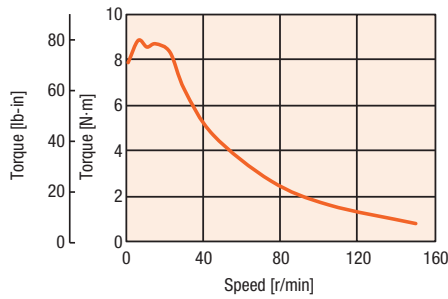

PKP245D15 Gear Ratio 20

Driver: CVD223FBR-K, Power Supply Voltage: 24 VDC, Current: 1.5 A/Phase

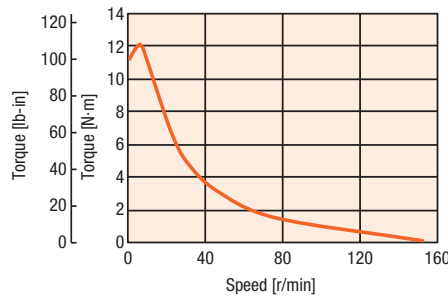

PKP245D23 Gear Ratio 20

Driver: CVD223FBR-K, Power Supply Voltage: 24 VDC, Current: 2.3 A/Phase

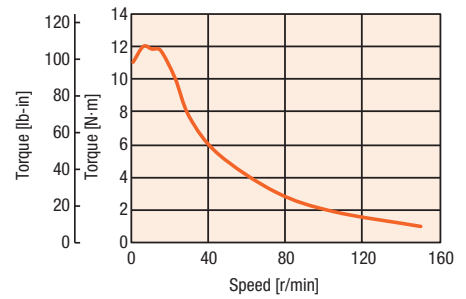

PKP244D23 Gear Ratio 40

Driver: CVD223FBR-K, Power Supply Voltage: 24 VDC, Current: 2.3 A/Phase

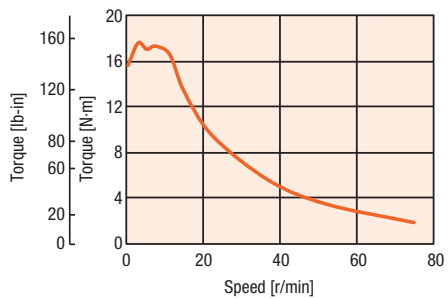

PKP245D15 Gear Ratio 40

Driver: CVD223FBR-K, Power Supply Voltage: 24 VDC, Current: 1.5 A/Phase

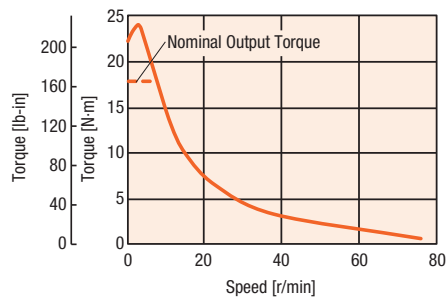

PKP245D23 Gear Ratio 40

Driver: CVD223FBR-K, Power Supply Voltage: 24 VDC, Current: 2.3 A/Phase

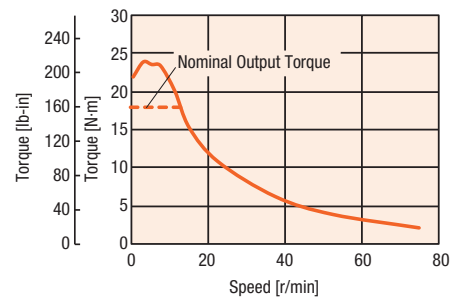

- Data for the speed-torque characteristics is based on Oriental Motor's internal conditions. If the conditions are changed, the characteristics may also change as a result.
- Depending on the driving conditions, a considerable amount of heat may be generated by the motor. Be sure to keep the motor case temperature at 100°C (212°F) or less. In case of product with encoder, be sure to keep the motor case temperature at 85°C (185°F) max. to protect the encoder.

◇ PKP246D15/PLE40

PKP246D15 Gear Ratio 5

Driver: CVD223FBR-K, Power Supply Voltage: 24 VDC, Current: 1.5 A/Phase

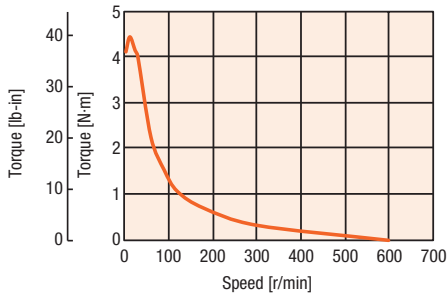

◇ PKP246D23/PLE40

PKP246D23 Gear Ratio 5

Driver: CVD223FBR-K, Power Supply Voltage: 24 VDC, Current: 2.3 A/Phase

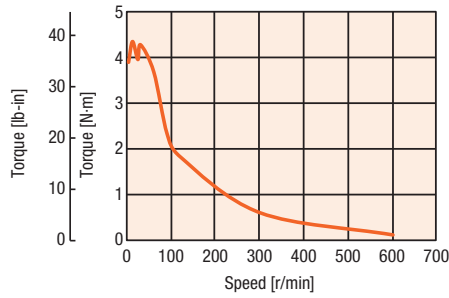

PKP246D15 Gear Ratio 10

Driver: CVD223FBR-K, Power Supply Voltage: 24 VDC, Current: 1.5 A/Phase

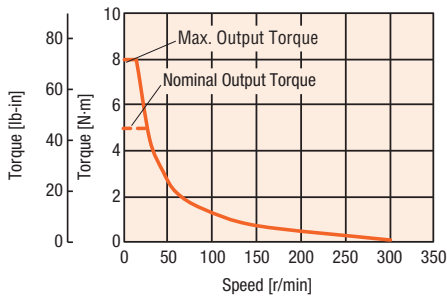

PKP246D23 Gear Ratio 10

Driver: CVD223FBR-K, Power Supply Voltage: 24 VDC, Current: 2.3 A/Phase

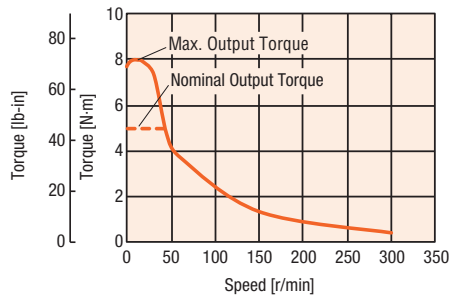

PKP246D15 Gear Ratio 20

Driver: CVD223FBR-K, Power Supply Voltage: 24 VDC, Current: 1.5 A/Phase

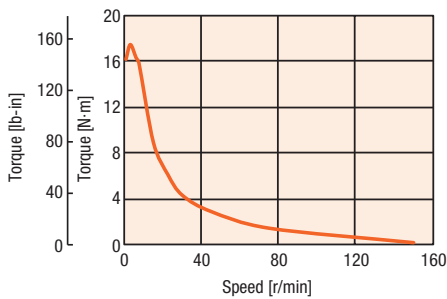

PKP246D23 Gear Ratio 20

Driver: CVD223FBR-K, Power Supply Voltage: 24 VDC, Current: 2.3 A/Phase

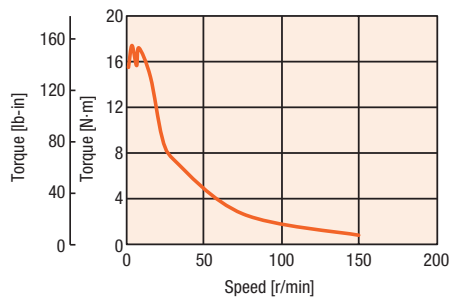

PKP246D15 Gear Ratio 40

Driver: CVD223FBR-K, Power Supply Voltage: 24 VDC, Current: 1.5 A/Phase

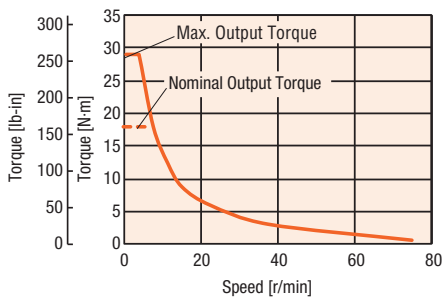

PKP246D23 Gear Ratio 40

Driver: CVD223FBR-K, Power Supply Voltage: 24 VDC, Current: 2.3 A/Phase

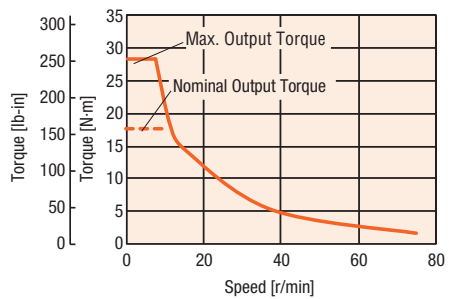

- Data for the speed-torque characteristics is based on Oriental Motor's internal conditions. If the conditions are changed, the characteristics may also change as a result.
- Depending on the driving conditions, a considerable amount of heat may be generated by the motor. Be sure to keep the motor case temperature at 100°C (212°F) or less. In case of product with encoder, be sure to keep the motor case temperature at 85°C (185°F) max. to protect the encoder.

Dimensions Unit = mm (in.)

Standard Type

2D & 3D CAD

Product Name	L1	L2	Mass kg (lb.)	CAD
PKP243D08A2	33 (1.30)	—	0.23 (0.51)	B1260
PKP243D08B2		48 (1.89)		
PKP243D15A2		—		
PKP243D15B2		48 (1.89)		
PKP243D23A2		—		
PKP243D23B2		48 (1.89)		
PKP244D08A2	39 (1.54)	—	0.3 (0.66)	B1261
PKP244D08B2		54 (2.13)		
PKP244D15A2		—		
PKP244D15B2		54 (2.13)		
PKP244D23A2		—		
PKP244D23B2		54 (2.13)		
PKP245D08A2	47 (1.85)	—	0.37 (0.82)	B1262
PKP245D08B2		62 (2.44)		
PKP245D15A2		—		
PKP245D15B2		62 (2.44)		
PKP245D23A2		—		
PKP245D23B2		62 (2.44)		
PKP246D15A2	59 (2.32)	—	0.5 (1.1)	B1263
PKP246D15B2		74 (2.91)		
PKP246D23A2		—		
PKP246D23B2		74 (2.91)		

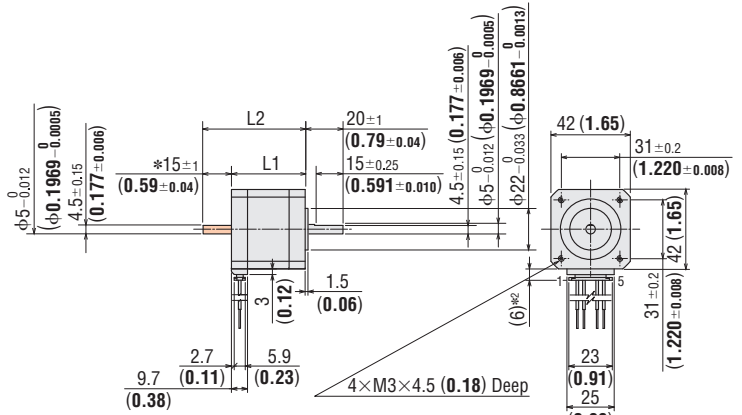

- *1 The length of the shaft flat on the double shaft model is 15±0.25 (0.591±0.010).
- *2 With connection cable
- These dimensions are for double shaft motors.
For single shaft motors, ignore the shaded areas.

Standard Type with Encoder

2D & 3D CAD

Product Name	L	Mass kg (lb.)	CAD
PKP243D15A2-R2E	46.5 (1.83)	0.24 (0.53)	B1321
PKP243D15A2-R2F			
PKP243D23A2-R2E			
PKP243D23A2-R2F			
PKP244D15A2-R2E	52.5 (2.07)	0.31 (0.68)	B1322
PKP244D15A2-R2F			
PKP244D23A2-R2E			
PKP244D23A2-R2F			
PKP245D15A2-R2E	60.5 (2.38)	0.38 (0.84)	B1323
PKP245D15A2-R2F			
PKP245D23A2-R2E			
PKP245D23A2-R2F			
PKP246D15A2-R2E	72.5 (2.85)	0.51 (1.12)	B1324
PKP246D15A2-R2F			
PKP246D23A2-R2E			
PKP246D23A2-R2F			

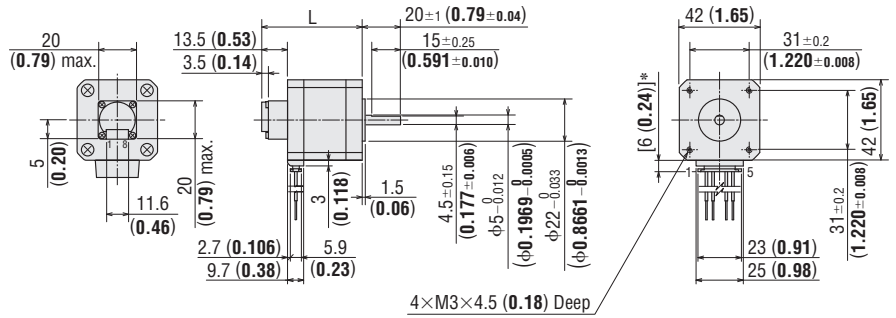

- *With connection cable

Encoder Connection Cable (Sold Separately)

Product Name	Applicable Encoder	Length L m (ft.)
LCE05A-006	Voltage Output	0.6 (2)
LCE08A-006	Line Driver Output	0.6 (2)

Applicable Connector

	Motor (HIROSE ELECTRIC CO., LTD.)	Encoder (Molex)
Connector Housing	MDF97-5S-3.5C	51021-0800
Contact	MDF97-22SC	50079-8100
Crimp Tool	HT801/MDF97-22S	57067-3000

Connection Cable (Sold separately)

Connection Cable for Motor

Product Name	Length L m (ft.)
LC2B06E	0.6 (2)

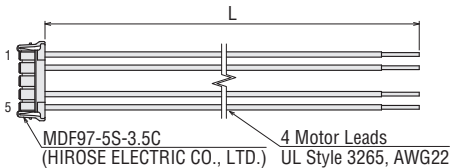

Voltage Output

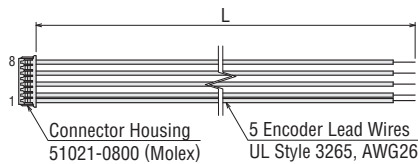

Line Driver Output

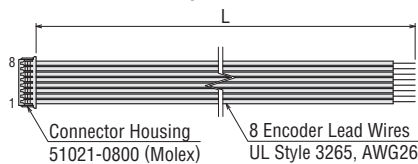

Inner Wiring Diagram of Motor

Wiring Diagram No.: Model A①

- Refer to page 25 for inner wiring diagram of motor.

Dimensions for Gearhead Unit = mm (in.)

● PLE40 Gearhead mm (in.)

3D CAD

Ratio	L1	L2	Mass kg (lb.)
5, 10	39 (2.05)	66.5 (2.6)	0.35 (0.77)
20, 40	52 (1.54)	79.5 (3.13)	0.45 (0.99)

● Use screw set **P00027** (sold separately) to attach Motor and Gearhead.

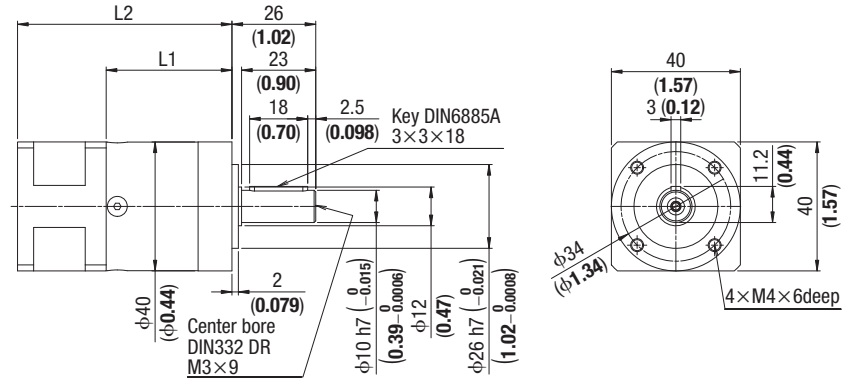

Standard Type Standard Type with Encoder

Frame Size 56.4 mm (2.22 in.) Bipolar 4 Lead Wires

Specifications

Product Name	Maximum Holding Torque N·m (oz·in)	Rotor Inertia J: kg·m ² (oz·in ²)	Rated Current A/Phase	Voltage VDC	Winding Resistance Ω/Phase	Inductance mH/Phase	Basic Step Angle	Recommended Driver Product Name*	
PKP264D14□2	0.74 (105)	140×10 ⁻⁷ (0.77)	1.4	2.9	2.1	6	1.8°	CVD228BR-K	
PKP264D28□2			2.8	1.6	0.57	1.5			
PKP264D42□2			4.2	1	0.24	0.65			
PKP266D14□2	1.4 (198)	270×10 ⁻⁷ (1.48)	1.4	4.6	3.3	12		CVD228BR-K	
PKP266D28□2			2.8	2.4	0.86	2.9			
PKP266D42□2			4.2	1.6	0.38	1.3			
PKP264D14A2-R2	0.74 (105)	140×10 ⁻⁷ (0.77)	1.4	2.9	2.1	6		1.8°	CVD228BR-K
PKP264D28A2-R2			2.8	1.6	0.57	1.5			
PKP264D42A2-R2			4.2	1	0.24	0.65			
PKP266D14A2-R2	1.4 (198)	270×10 ⁻⁷ (1.48)	1.4	4.6	3.3	12			CVD228BR-K
PKP266D28A2-R2			2.8	2.4	0.86	2.9			
PKP266D42A2-R2			4.2	1.6	0.38	1.3			
PKP268D14A2-R2	2.5 (350)	500×10 ⁻⁷ (2.7)	1.4	6.6	4.7	18	1.8°		CVD228BR-K
PKP268D28A2-R2			2.8	3.4	1.2	4.6			
PKP268D42A2-R2			4.2	2.2	0.53	2			

● The box □ in the product name indicates the shaft **A** (single shaft) or **B** (double shaft).

The box □ in the product name indicates the encoder resolution **E** (200 P/R) or **F** (400 P/R).

The box □ in the product name indicates the encoder output circuit type **L** (line driver output). The voltage output type will have no "□" in the product name.

● See page 25 for encoder specifications.

PLE60 Gearhead Specifications for Metric Motor Shaft¹

Gear Head Product Name ¹	Base Motor	Gear Ratio	Holding Torque	Basic Step Angle	Permissible Torque	Maximum Torque	Backlash arcmin	Speed Range 0~ (r/min)
			N·m (lb·in)	deg/step	N·m (lb·in)	N·m (lb·in)		
PLE60-5B	PKP264D14□□	5	3.33 (29)	0.36	*	*	10	200
PLE60-10B	PKP264D14□□	10	6.66 (60)	0.18	*	*		100
PLE60-20B	PKP264D14□□	20	13.32 (118)	0.09	*	*	12	50
PLE60-40B	PKP264D14□□	40	26.64 (236)	0.045	*	*		25
PLE60-5B	PKP264D28□□	5	3.33 (29)	0.36	*	*	10	500
PLE60-10B	PKP264D28□□	10	6.66 (59)	0.18	*	*		250
PLE60-20B	PKP264D28□□	20	13.32 (118)	0.09	*	*	12	125
PLE60-40B	PKP264D28□□	40	26.64 (236)	0.045	*	*		62.5
PLE60-5B	PKP264D42□□	5	3.33 (29)	0.36	*	*	10	600
PLE60-10B	PKP264D42□□	10	6.66 (59)	0.18	*	*		300
PLE60-20B	PKP264D42□□	20	13.32 (118)	0.09	*	*	12	150
PLE60-40B	PKP264D42□□	40	26.64 (236)	0.045	*	*		75
PLE60-5B	PKP266D14□□	5	6.3 (56)	0.36	*	*	10	160
PLE60-10B	PKP266D14□□	10	12.6 (112)	0.18	*	*		80
PLE60-20B	PKP266D14□□	20	25.2 (223)	0.09	*	*	12	40
PLE60-40B	PKP266D14□□	40	40 (354)	0.045	40 (354)	*		20
PLE60-5B	PKP266D28□□	5	6.3 (56)	0.36	*	*	10	300
PLE60-10B	PKP266D28□□	10	12.6 (112)	0.18	*	*		150
PLE60-20B	PKP266D28□□	20	25.2 (223)	0.09	*	*	12	75
PLE60-40B	PKP266D28□□	40	40 (354)	0.045	40 (354)	*		37.5
PLE60-5B	PKP266D42□□	5	6.3 (56)	0.36	*	*	10	500
PLE60-10B	PKP266D42□□	10	12.6 (112)	0.18	*	*		250
PLE60-20B	PKP266D42□□	20	25.2 (223)	0.09	*	*	12	125
PLE60-40B	PKP266D42□□	40	40 (354)	0.045	40 (354)	*		62.5
PLE60-5B	PKP268D14□□	5	11.25 (100)	0.36	*	*	10	60
PLE60-10B	PKP268D14□□	10	15 (133)	0.18	15 (133)	*		30
PLE60-20B	PKP268D14□□	20	44 (389)	0.09	44 (389)	*	12	15
PLE60-40B	PKP268D14□□	40	40 (354)	0.045	40 (354)	*		7.5
PLE60-5B	PKP268D28□□	5	11.25 (100)	0.36	*	*	10	180
PLE60-10B	PKP268D28□□	10	15 (133)	0.18	15 (133)	*		90
PLE60-20B	PKP268D28□□	20	44 (389)	0.09	44 (389)	*	12	45
PLE60-40B	PKP268D28□□	40	40 (354)	0.045	40 (354)	64 (566)		22.5
PLE60-5B	PKP268D42□□	5	11.25 (100)	0.36	*	*	10	240
PLE60-10B	PKP268D42□□	10	15 (133)	0.18	15 (133)	*		120
PLE60-20B	PKP268D42□□	20	44 (389)	0.09	44 (389)	*	12	60
PLE60-40B	PKP268D42□□	40	40 (354)	0.045	40 (354)	64 (566)		30

1. Gear Head for Inch Shaft (0.2500) 1/2" shaft. Select **PLE60-□D**. Same specifications apply.

*Torque does not reach the permissible output of the PLE Gear head

● Use screw set **PO0028** (sold separately) to attach Motor and Gearhead

Speed – Torque Characteristics (Reference Values)

◇ PKP264D14/PLE60

PKP264D14 Gear Ratio 5

Driver: CVD228BR-K, Power Supply Voltage: 24 VDC, Current: 2.8 A/Phase

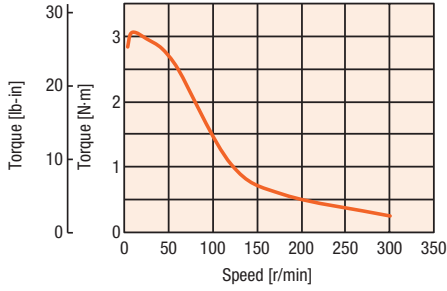

◇ PKP264D28/PLE60

PKP264D28 Gear Ratio 5

Driver: CVD228BR-K, Power Supply Voltage: 24 VDC, Current: 2.8 A/Phase

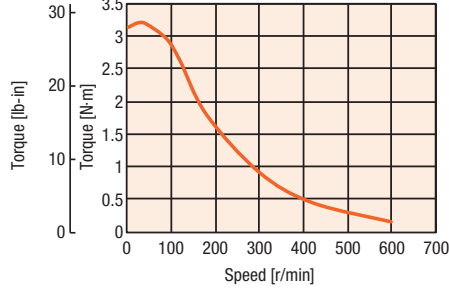

◇ PKP264D42/PLE60

PKP264D42 Gear Ratio 5

Driver: CVD242BR-K, Power Supply Voltage: 24 VDC, Current: 4.2 A/Phase

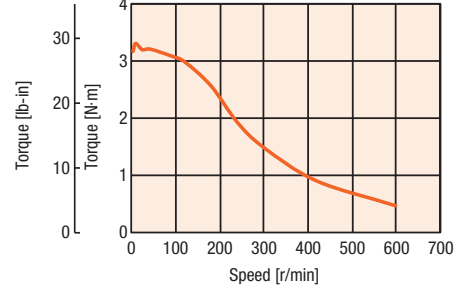

PKP264D14 Gear Ratio 10

Driver: CVD228BR-K, Power Supply Voltage: 24 VDC, Current: 2.8 A/Phase

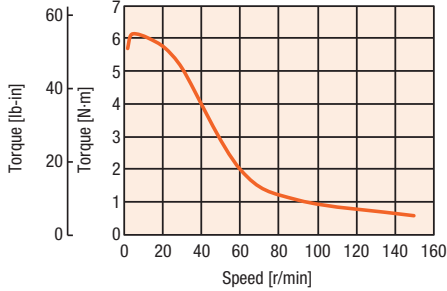

PKP264D28 Gear Ratio 10

Driver: CVD228BR-K, Power Supply Voltage: 24 VDC, Current: 2.8 A/Phase

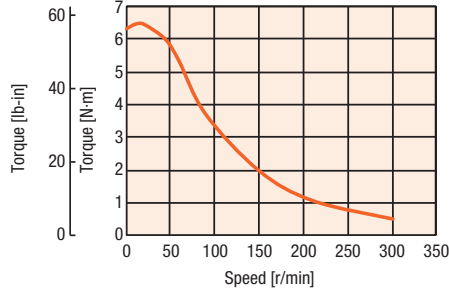

PKP264D42 Gear Ratio 10

Driver: CVD242BR-K, Power Supply Voltage: 24 VDC, Current: 4.2 A/Phase

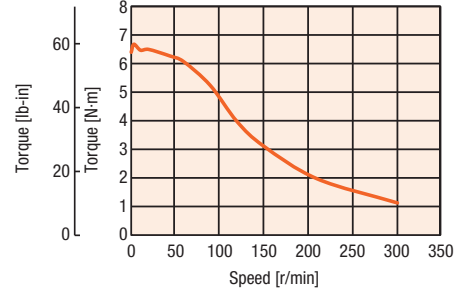

PKP264D14 Gear Ratio 20

Driver: CVD228BR-K, Power Supply Voltage: 24 VDC, Current: 2.8 A/Phase

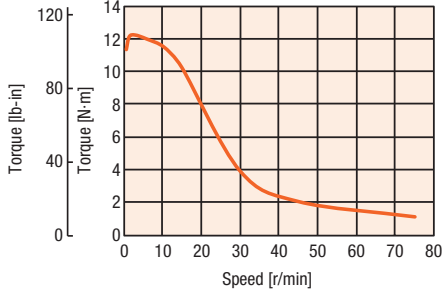

PKP264D28 Gear Ratio 20

Driver: CVD228BR-K, Power Supply Voltage: 24 VDC, Current: 2.8 A/Phase

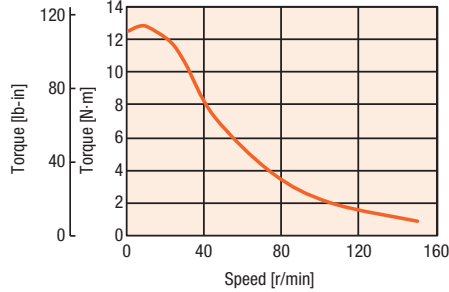

PKP264D42 Gear Ratio 20

Driver: CVD242BR-K, Power Supply Voltage: 24 VDC, Current: 4.2 A/Phase

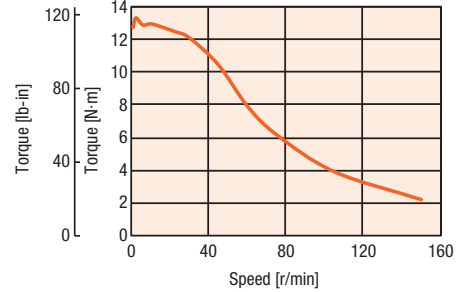

PKP264D14 Gear Ratio 40

Driver: CVD228BR-K, Power Supply Voltage: 24 VDC, Current: 2.8 A/Phase

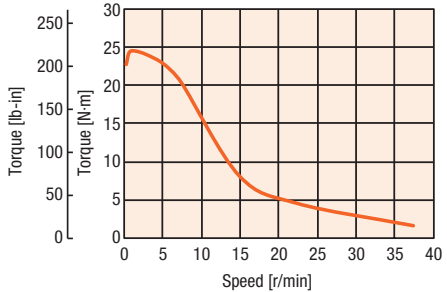

PKP264D28 Gear Ratio 40

Driver: CVD228BR-K, Power Supply Voltage: 24 VDC, Current: 2.8 A/Phase

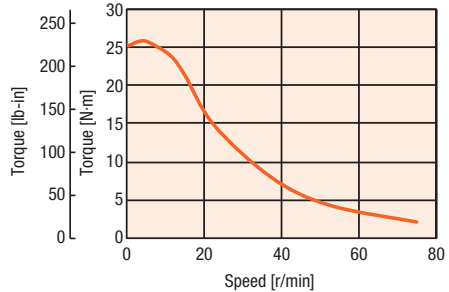

PKP264D42 Gear Ratio 40

Driver: CVD242BR-K, Power Supply Voltage: 24 VDC, Current: 4.2 A/Phase

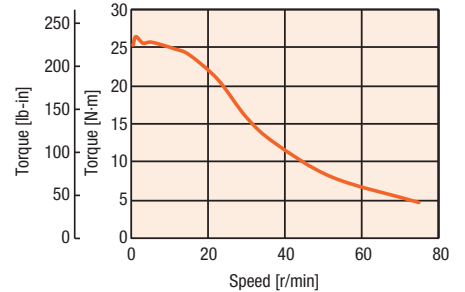

- Data for the speed-torque characteristics is based on Oriental Motor's internal conditions. If the conditions are changed, the characteristics may also change as a result.
- Depending on the driving conditions, a considerable amount of heat may be generated by the motor. Be sure to keep the motor case temperature at 100°C (212°F) or less. In case of product with encoder, be sure to keep the motor case temperature at 85°C (185°F) max. to protect the encoder.

◇ PKP266D14/PLE60

PKP266D14 Gear Ratio 5

Driver: CVD228BR-K, Power Supply Voltage: 24 VDC, Current: 2.8 A/Phase

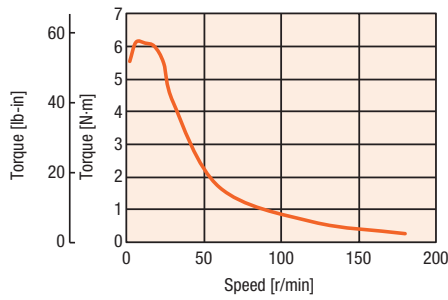

◇ PKP266D28/PLE60

PKP266D28 Gear Ratio 5

Driver: CVD228BR-K, Power Supply Voltage: 24 VDC, Current: 2.8 A/Phase

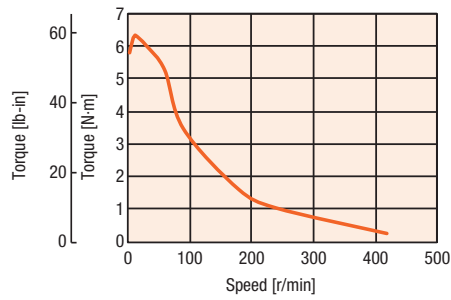

◇ PKP266D42/PLE60

PKP266D42 Gear Ratio 5

Driver: CVD242BR-K, Power Supply Voltage: 24 VDC, Current: 4.2 A/Phase

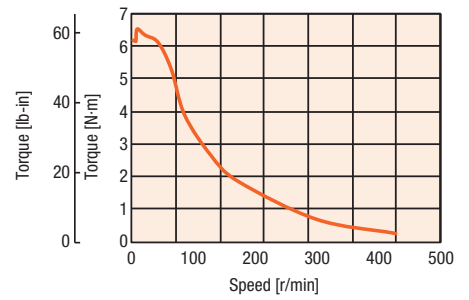

PKP266D14 Gear Ratio 10

Driver: CVD228BR-K, Power Supply Voltage: 24 VDC, Current: 2.8 A/Phase

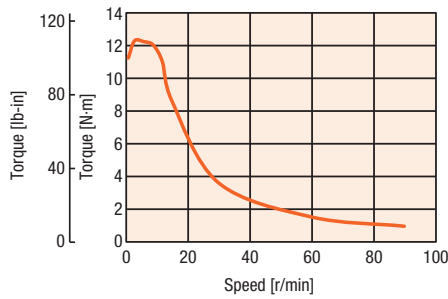

PKP266D28 Gear Ratio 10

Driver: CVD228BR-K, Power Supply Voltage: 24 VDC, Current: 2.8 A/Phase

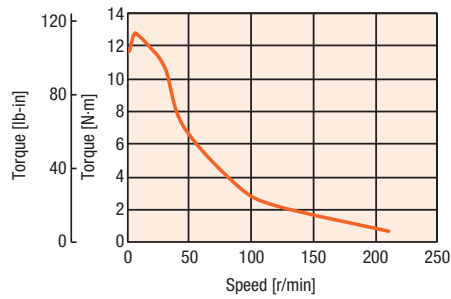

PKP266D42 Gear Ratio 10

Driver: CVD242BR-K, Power Supply Voltage: 24 VDC, Current: 4.2 A/Phase

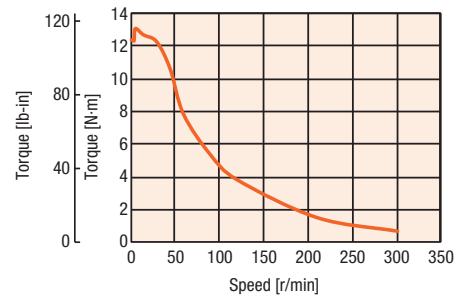

PKP266D14 Gear Ratio 20

Driver: CVD228BR-K, Power Supply Voltage: 24 VDC, Current: 2.8 A/Phase

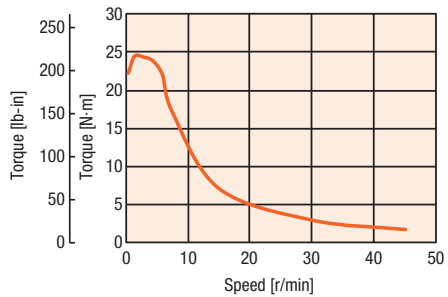

PKP266D28 Gear Ratio 20

Driver: CVD228BR-K, Power Supply Voltage: 24 VDC, Current: 2.8 A/Phase

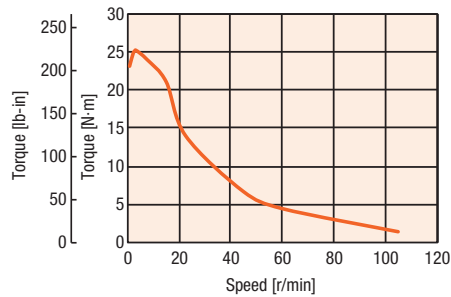

PKP266D42 Gear Ratio 20

Driver: CVD242BR-K, Power Supply Voltage: 24 VDC, Current: 4.2 A/Phase

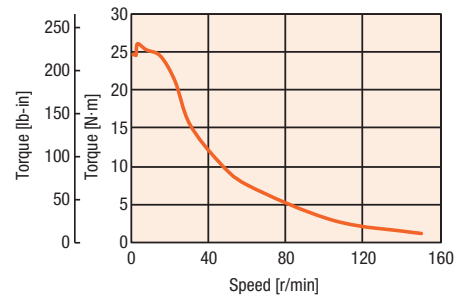

PKP266D14 Gear Ratio 40

Driver: CVD228BR-K, Power Supply Voltage: 24 VDC, Current: 2.8 A/Phase

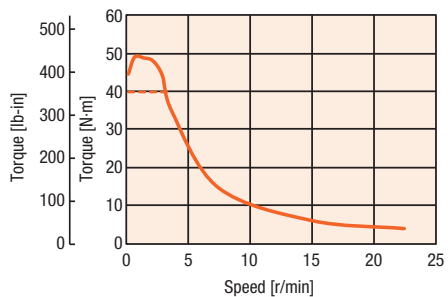

PKP266D28 Gear Ratio 40

Driver: CVD228BR-K, Power Supply Voltage: 24 VDC, Current: 2.8 A/Phase

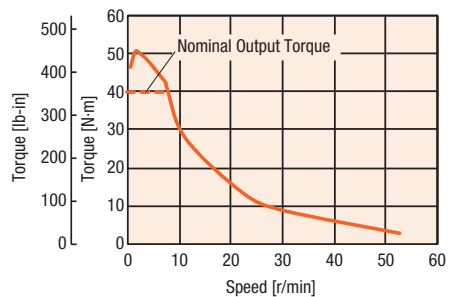

PKP266D42 Gear Ratio 40

Driver: CVD242BR-K, Power Supply Voltage: 24 VDC, Current: 4.2 A/Phase

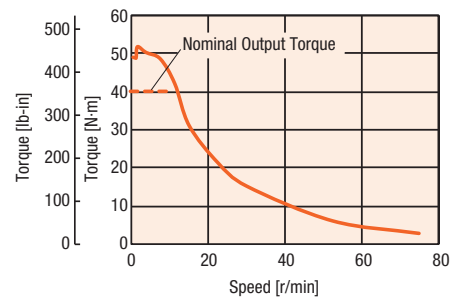

- Data for the speed-torque characteristics is based on Oriental Motor's internal conditions. If the conditions are changed, the characteristics may also change as a result.
- Depending on the driving conditions, a considerable amount of heat may be generated by the motor. Be sure to keep the motor case temperature at 100°C (212°F) or less. In case of product with encoder, be sure to keep the motor case temperature at 85°C (185°F) max. to protect the encoder.

◇ PKP268D14/PLE60

PKP268D14 Gear Ratio 5

Driver: CVD228BR-K, Power Supply Voltage: 24 VDC, Current: 2.8 A/Phase

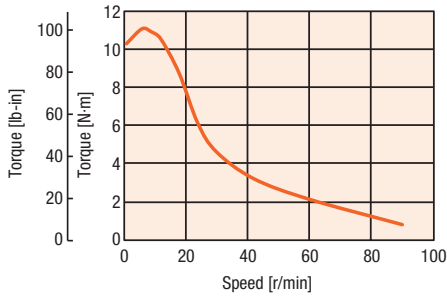

◇ PKP268D28/PLE60

PKP268D28 Gear Ratio 5

Driver: CVD228BR-K, Power Supply Voltage: 24 VDC, Current: 2.8 A/Phase

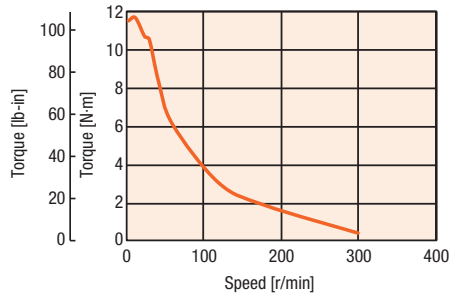

◇ PKP268D42/PLE60

PKP268D42 Gear Ratio 5

Driver: CVD242BR-K, Power Supply Voltage: 24 VDC, Current: 4.2 A/Phase

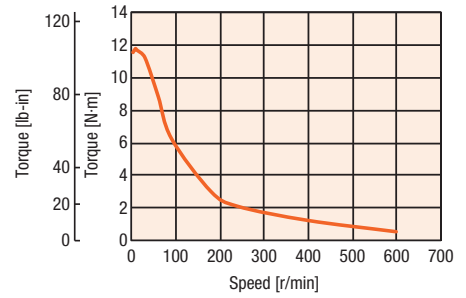

PKP268D14 Gear Ratio 10

Driver: CVD228BR-K, Power Supply Voltage: 24 VDC, Current: 2.8 A/Phase

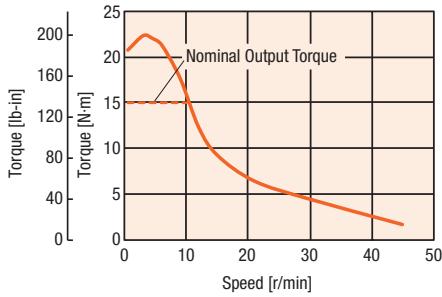

PKP268D28 Gear Ratio 10

Driver: CVD228BR-K, Power Supply Voltage: 24 VDC, Current: 2.8 A/Phase

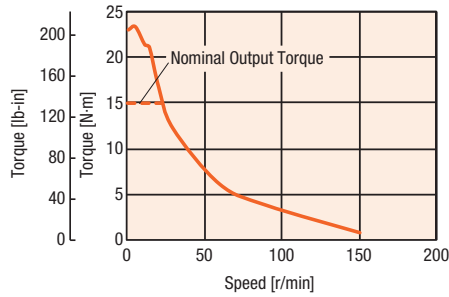

PKP268D42 Gear Ratio 10

Driver: CVD242BR-K, Power Supply Voltage: 24 VDC, Current: 4.2 A/Phase

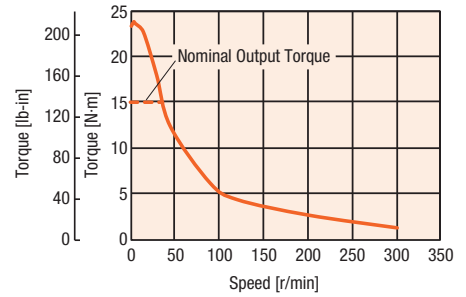

PKP268D14 Gear Ratio 20

Driver: CVD228BR-K, Power Supply Voltage: 24 VDC, Current: 2.8 A/Phase

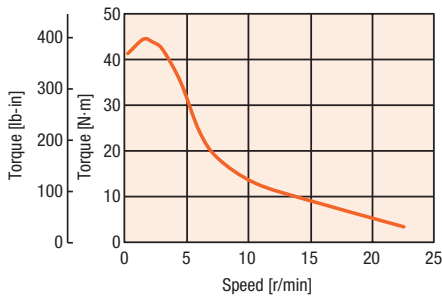

PKP268D28 Gear Ratio 20

Driver: CVD228BR-K, Power Supply Voltage: 24 VDC, Current: 2.8 A/Phase

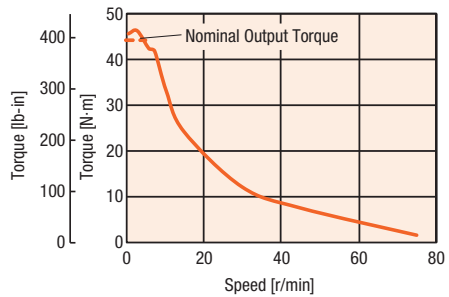

PKP268D42 Gear Ratio 20

Driver: CVD242BR-K, Power Supply Voltage: 24 VDC, Current: 4.2 A/Phase

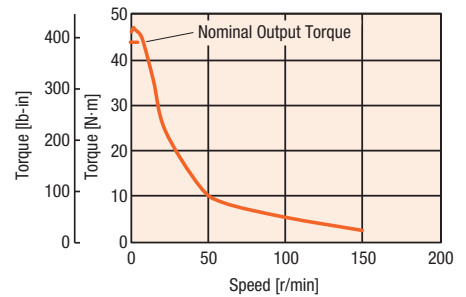

PKP268D14 Gear Ratio 40

Driver: CVD228BR-K, Power Supply Voltage: 24 VDC, Current: 2.8 A/Phase

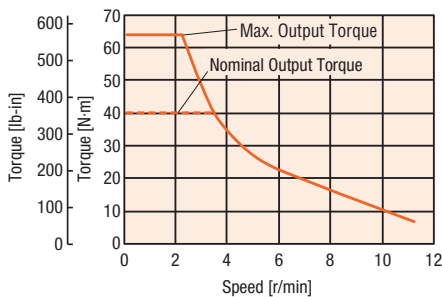

PKP268D28 Gear Ratio 40

Driver: CVD228BR-K, Power Supply Voltage: 24 VDC, Current: 2.8 A/Phase

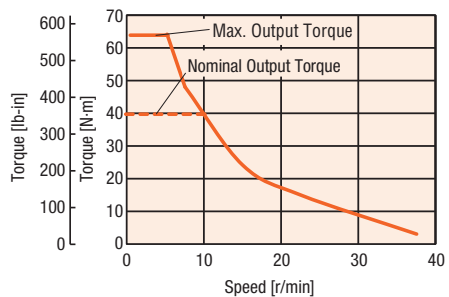

PKP268D42 Gear Ratio 40

Driver: CVD242BR-K, Power Supply Voltage: 24 VDC, Current: 4.2 A/Phase

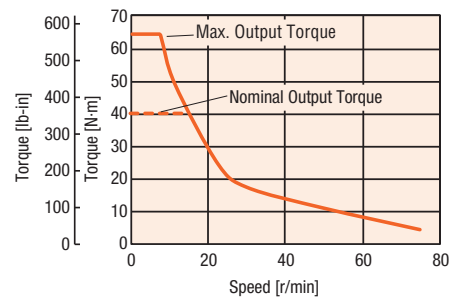

- Data for the speed-torque characteristics is based on Oriental Motor's internal conditions. If the conditions are changed, the characteristics may also change as a result.
- Depending on the driving conditions, a considerable amount of heat may be generated by the motor. Be sure to keep the motor case temperature at 100°C (212°F) or less. In case of product with encoder, be sure to keep the motor case temperature at 85°C (185°F) max. to protect the encoder.

Dimensions Unit = mm (in.)

Standard Type

Product Name	L1	L2	Mass kg (lb.)
PKP264D14A2	39 (1.54)	—	0.45 (0.99)
PKP264D14B2		55 (2.17)	
PKP264D28A2		—	
PKP264D28B2		55 (2.17)	
PKP264D42A2		—	
PKP266D14A2	54 (2.13)	—	0.7 (1.54)
PKP266D14B2		70 (2.76)	
PKP266D28A2		—	
PKP266D28B2		70 (2.76)	
PKP266D42A2		—	
PKP266D42B2	70 (2.76)	—	—

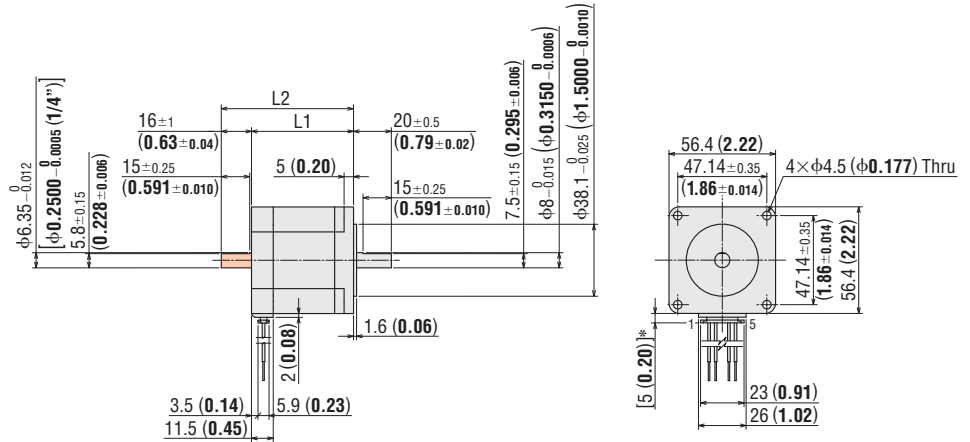

*With connection cable

- These dimensions are for double shaft motors.
- For single shaft motors, ignore the shaded areas.

Applicable Connector

	Motor (HIROSE ELECTRIC CO.,LTD.)
Connector Housing	MDF97-5S-3.5C
Contact	MDF97-22SC
Cimpring Tool	HT801/MDF97-22S

Standard Type with Encoder

Product Name	L	Mass kg (lb.)
PKP264D14A2-R2	55.5 (2.19)	0.45 (0.99)
PKP264D28A2-R2		
PKP264D42A2-R2		
PKP266D14A2-R2	70.5 (2.78)	0.7 (1.54)
PKP266D28A2-R2		
PKP266D42A2-R2		
PKP268D14A2-R2	92.5 (3.64)	1.1 (2.4)
PKP268D28A2-R2		
PKP268D42A2-R2		

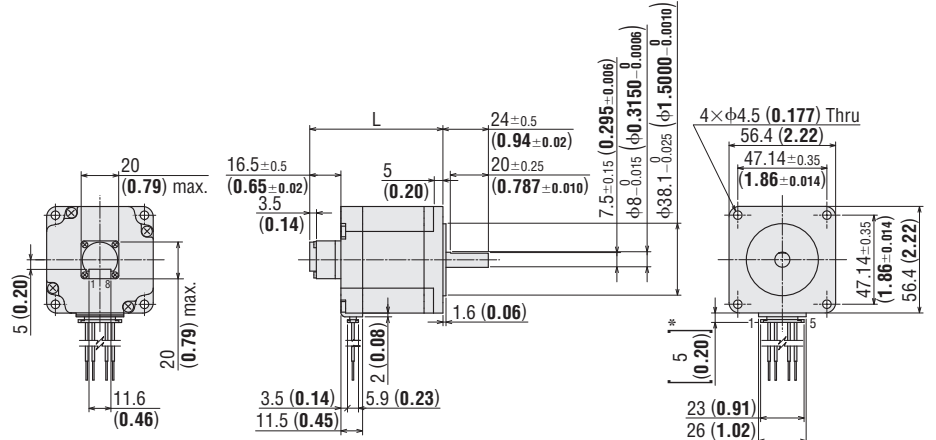

*With connection cable

Applicable Connector

	Motor (HIROSE ELECTRIC CO.,LTD.)	Encoder (Molex)
Connector Housing	MDF97-5S-3.5C	51021-0800
Contact	MDF97-22SC	50079-8100
Crimping Tool	HT801/MDF97-22S	57067-3000

Motor Connection Cable (Sold Separately)

Product Name	Length L m (ft.)
LC2B06E	0.6 (2)

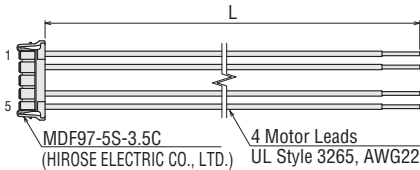

Encoder Connection Cable (Sold Separately)

Product Name	Applicable Encoder	Length L m (ft.)
LCE05A-006	Voltage Output	0.6 (2)
LCE08A-006	Line Driver Output	0.6 (2)

◇ Voltage Output

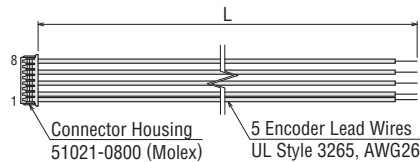

◇ Line Driver Output

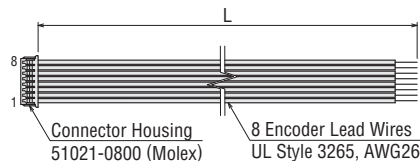

Inner Wiring Diagram of Motor

Wiring Diagram No.: A①

- Refer to page 25 for inner wiring diagram of motor.

Dimensions for Gearhead Unit = mm (in.)

● PLE60 Gearhead mm (in.)

3D CAD

Ratio	L1	L2	Mass kg (lb.)
5, 10	47 (1.85)	73 (2.9)	0.9
20, 40	59.5 (2.3)	85.5 (3.4)	1.1

● Use screw set **P00028** (sold separately) to attach Motor and Gearhead.

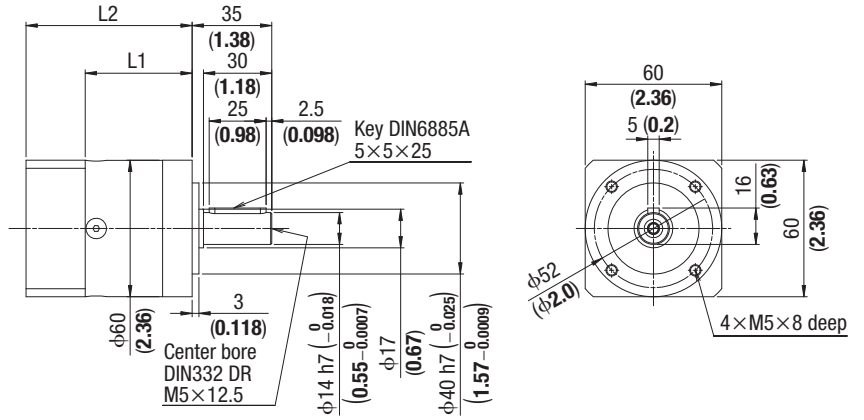

Standard Type

Frame Size 85 mm (3.35 in.) Bipolar 4 Lead Wires

Specifications

Product Name	Maximum Holding Torque N·m (lb·in)	Rotor Inertia J: kg·m ² (oz·in ²)	Rated Current A/Phase	Voltage VDC	Winding Resistance Ω/Phase	Inductance mH/Phase	Basic Step Angle	Recommended Driver Product Name*
PKP296D45□	3.3 (29)	1100×10 ⁻⁷ (6)	4.5	1.9	0.42	3.1	1.8°	CVD245BR-K
PKP296D63□			6.3	1.4	0.23	1.6		-
PKP299D45□	6.4 (56)	2200×10 ⁻⁷ (12)	4.5	2.7	0.6	5.4		CVD245BR-K
PKP299D63□			6.3	2	0.32	2.6		-
PKP2913D45□	9.5 (84)	3400×10 ⁻⁷ (18.6)	4.5	3.5	0.78	6.9		CVD245BR-K
PKP2913D56□			5.6	2.6	0.47	4.4		-

● The box □ in the product name indicates the shaft **A** (single shaft) or **B** (double shaft).

PLE80 Gearhead Specifications for Metric Motor Shaft¹

Gear Head Product Name ¹	Base Motor	Gear Ratio	Holding Torque	Basic Step Angle	Permissible Torque	Maximum Torque	Backlash arcmin	Speed Range
			N·m (lb·in)	deg/step	N·m (lb·in)	N·m (lb·in)		0~ (r/min)
PLE80-5B	PKP296D45□□	5	14.85 (131)	0.36	*	*	7	200
PLE80-10B	PKP296D45□□	10	29.7 (263)	0.18	*	*		100
PLE80-20B	PKP296D45□□	20	59.4 (526)	0.09	*	*	9	50
PLE80-40B	PKP296D45□□	40	110 (974)	0.045	110 (974)	*		25
PLE80-5B	PKP296D63□□	5	14.85 (131)	0.36	*	*	7	800
PLE80-10B	PKP296D63□□	10	29.7 (263)	0.18	*	*		400
PLE80-20B	PKP296D63□□	20	59.4 (526)	0.09	*	*	9	200
PLE80-40B	PKP296D63□□	40	110 (974)	0.045	110 (974)	*		100
PLE80-5B	PKP299D45□□	5	28.8 (255)	0.36	*	*	7	100
PLE80-10B	PKP299D45□□	10	38 (336)	0.18	38 (336)	*		50
PLE80-20B	PKP299D45□□	20	115.2 (1020)	0.09	*	*	9	25
PLE80-40B	PKP299D45□□	40	110 (974)	0.045	110 (974)	176 (1558)		12.5
PLE80-5B	PKP299D63□□	5	28.8 (255)	0.36	*	*	7	400
PLE80-10B	PKP299D63□□	10	38 (336)	0.18	38 (336)	*		200
PLE80-20B	PKP299D63□□	20	115.2 (1920)	0.09	*	*	9	100
PLE80-40B	PKP299D63□□	40	110 (974)	0.045	110 (974)	176 (1558)		50
PLE80-5B	PKP2913D45□□	5	42.75 (378)	0.36	*	*	7	80
PLE80-10B	PKP2913D45□□	10	38 (336)	0.18	38 (336)	61 (540)		40
PLE80-20B	PKP2913D45□□	20	120 (1062)	0.09	120 (1062)	*	9	20
PLE80-40B	PKP2913D45□□	40	110 (974)	0.045	110 (974)	176 (1558)		10
PLE80-5B	PKP2913D56□□	5	42.75 (378)	0.36	*	*	7	300
PLE80-10B	PKP2913D56□□	10	38 (336)	0.18	38 (336)	61 (540)		150
PLE80-20B	PKP2913D56□□	20	120 (1062)	0.09	120 (1062)	*	9	75
PLE80-40B	PKP2913D56□□	40	110 (974)	0.045	110 (974)	176 (1558)		37.5

1. Gear Head for Inch Shaft (0.5000) 1/2" shaft. Select **PLE80-□D**. Same specifications apply.

*Torque does not reach the permissible output of the PLE Gear head

● Use screw set **P00029** (sold separately) to attach Motor and Gearhead

Speed – Torque Characteristics (Reference Values)

◇ PKP296D45/PLE80

PKP296D45 Gear Ratio 5

Driver: CVD245BR-K, Power Supply Voltage: 24 VDC, Current: 4.5 A/Phase

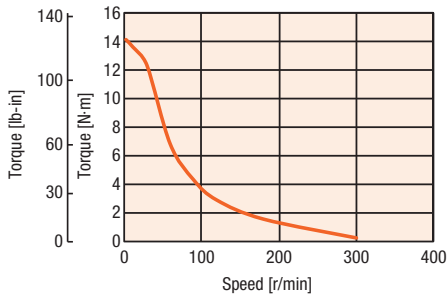

◇ PKP296D63/PLE80

PKP296D63 Gear Ratio 5

Constant Current Driver, Power Supply Voltage: 80 VDC, Current: 6.3 A/Phase

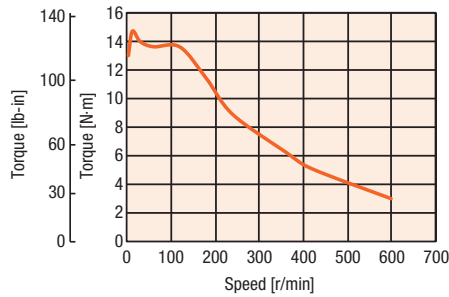

PKP296D45 Gear Ratio 10

Driver: CVD245BR-K, Power Supply Voltage: 24 VDC, Current: 4.5 A/Phase

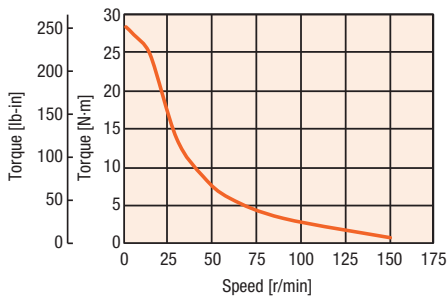

PKP296D63 Gear Ratio 10

Constant Current Driver, Power Supply Voltage: 80 VDC, Current: 6.3 A/Phase

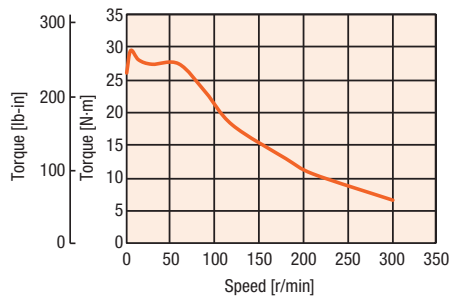

PKP296D45 Gear Ratio 20

Driver: CVD245BR-K, Power Supply Voltage: 24 VDC, Current: 4.5 A/Phase

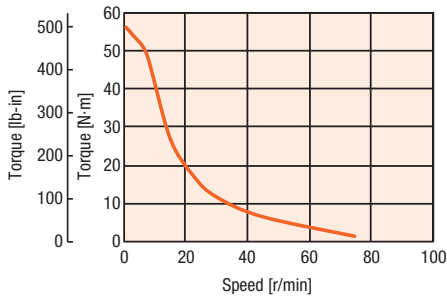

PKP296D63 Gear Ratio 20

Constant Current Driver, Power Supply Voltage: 80 VDC, Current: 6.3 A/Phase

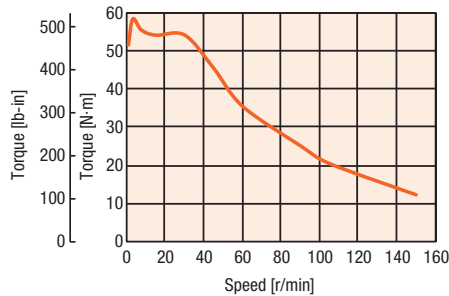

PKP296D45 Gear Ratio 40

Driver: CVD245BR-K, Power Supply Voltage: 24 VDC, Current: 4.5 A/Phase

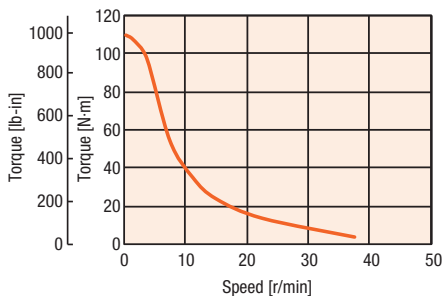

PKP296D63 Gear Ratio 40

Constant Current Driver, Power Supply Voltage: 80 VDC, Current: 6.3 A/Phase

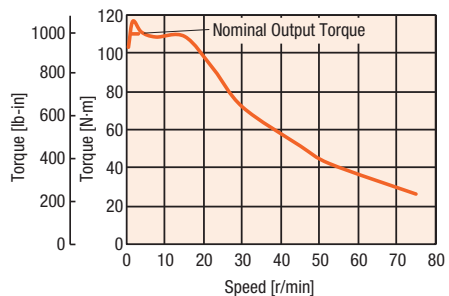

- Data for the speed-torque characteristics is based on Oriental Motor's internal conditions. If the conditions are changed, the characteristics may also change as a result.
- Depending on the driving conditions, a considerable amount of heat may be generated by the motor. Be sure to keep the motor case temperature at 100°C (212°F) or less. In case of product with encoder, be sure to keep the motor case temperature at 85°C (185°F) max. to protect the encoder.

◇ PKP299D45/PLE80

PKP299D45 Gear Ratio 5

Driver: CVD245BR-K, Power Supply Voltage: 24 VDC, Current: 4.5 A/Phase

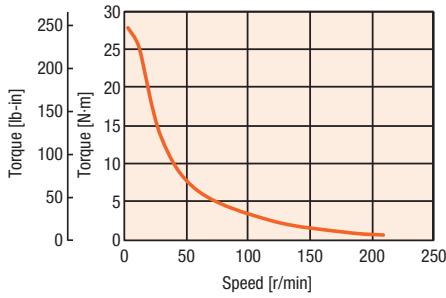

◇ PKP299D63/PLE80

PKP299D63 Gear Ratio 5

Constant Current Driver, Power Supply Voltage: 80 VDC, Current: 6.3 A/Phase

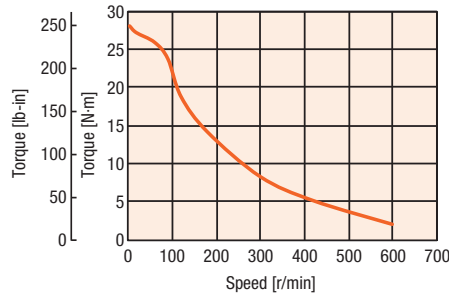

PKP299D45 Gear Ratio 10

Driver: CVD245BR-K, Power Supply Voltage: 24 VDC, Current: 4.5 A/Phase

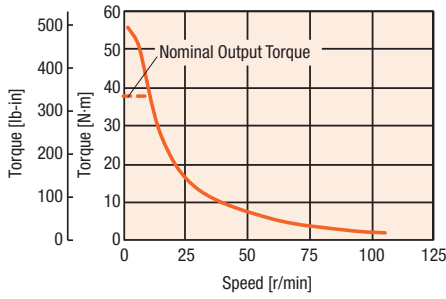

PKP299D63 Gear Ratio 10

Constant Current Driver, Power Supply Voltage: 80 VDC, Current: 6.3 A/Phase

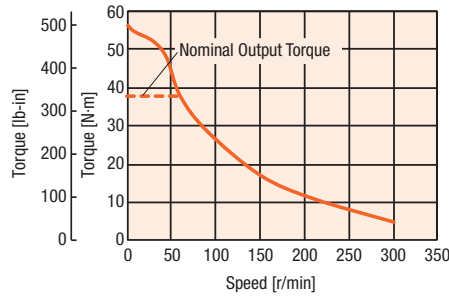

PKP299D45 Gear Ratio 20

Driver: CVD245BR-K, Power Supply Voltage: 24 VDC, Current: 4.5 A/Phase

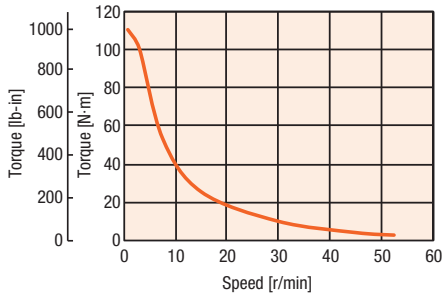

PKP299D63 Gear Ratio 20

Constant Current Driver, Power Supply Voltage: 80 VDC, Current: 6.3 A/Phase

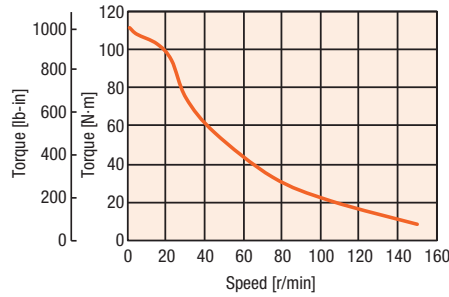

PKP299D45 Gear Ratio 40

Driver: CVD245BR-K, Power Supply Voltage: 24 VDC, Current: 4.5 A/Phase

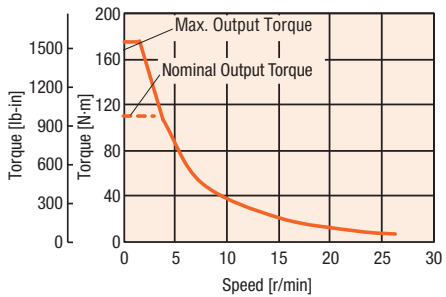

PKP299D63 Gear Ratio 40

Constant Current Driver, Power Supply Voltage: 80 VDC, Current: 6.3 A/Phase

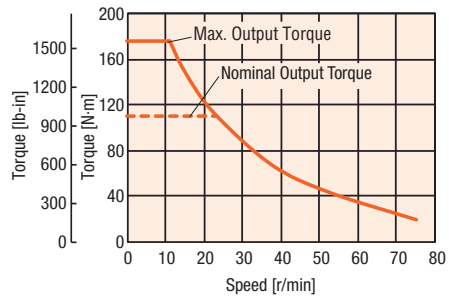

- Data for the speed-torque characteristics is based on Oriental Motor's internal conditions. If the conditions are changed, the characteristics may also change as a result.
- Depending on the driving conditions, a considerable amount of heat may be generated by the motor. Be sure to keep the motor case temperature at 100°C (212°F) or less. In case of product with encoder, be sure to keep the motor case temperature at 85°C (185°F) max. to protect the encoder.

◇ PKP2913D45/PLE80

PKP2913D45 Gear Ratio 5

Driver: CVD245BR-K, Power Supply Voltage: 24 VDC, Current: 4.5 A/Phase

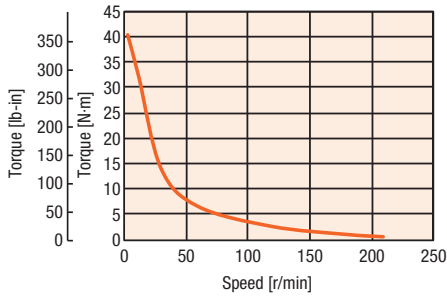

◇ PKP2913D56/PLE80

PKP2913D56 Gear Ratio 5

Constant Current Driver, Power Supply Voltage: 80 VDC, Current: 5.6 A/Phase

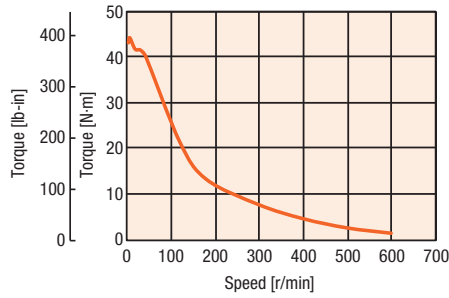

PKP2913D45 Gear Ratio 10

Driver: CVD245BR-K, Power Supply Voltage: 24 VDC, Current: 4.5 A/Phase

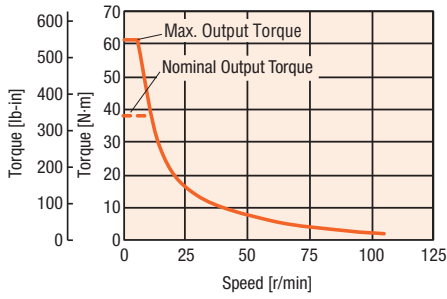

PKP2913D56 Gear Ratio 10

Constant Current Driver, Power Supply Voltage: 80 VDC, Current: 5.6 A/Phase

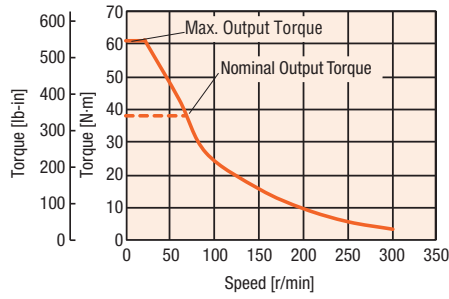

PKP2913D45 Gear Ratio 20

Driver: CVD245BR-K, Power Supply Voltage: 24 VDC, Current: 4.5 A/Phase

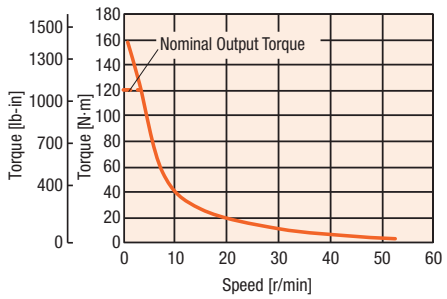

PKP2913D56 Gear Ratio 20

Constant Current Driver, Power Supply Voltage: 80 VDC, Current: 5.6 A/Phase

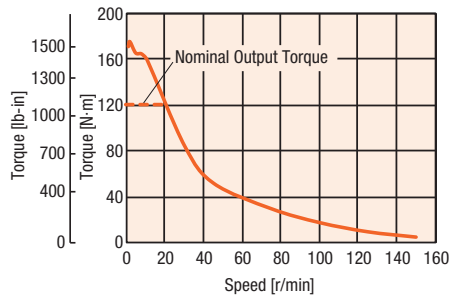

PKP2913D45 Gear Ratio 40

Driver: CVD245BR-K, Power Supply Voltage: 24 VDC, Current: 4.5 A/Phase

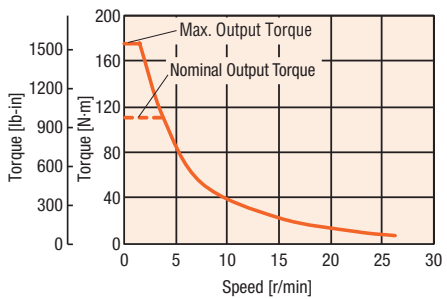

PKP2913D56 Gear Ratio 40

Constant Current Driver, Power Supply Voltage: 80 VDC, Current: 5.6 A/Phase

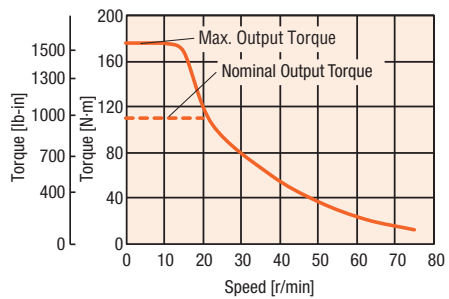

- Data for the speed-torque characteristics is based on Oriental Motor's internal conditions. If the conditions are changed, the characteristics may also change as a result.
- Depending on the driving conditions, a considerable amount of heat may be generated by the motor. Be sure to keep the motor case temperature at 100°C (212°F) or less. In case of product with encoder, be sure to keep the motor case temperature at 85°C (185°F) max. to protect the encoder.

Dimensions Unit = mm (in.)

Motor

Product Name	L1	L2	Mass kg (lb.)
PKP296D45A	66 (2.60)	-	1.8 (3.97)
PKP296D45B		100 (3.94)	
PKP296D63A		-	
PKP296D63B		100 (3.94)	
PKP299D45A	96 (3.78)	-	2.9 (6.39)
PKP299D45B		130 (5.12)	
PKP299D63A		-	
PKP299D63B		130 (5.12)	
PKP2913D45A	126 (4.96)	-	4 (8.82)
PKP2913D45B		160 (6.30)	
PKP2913D56A		-	
PKP2913D56B		160 (6.30)	

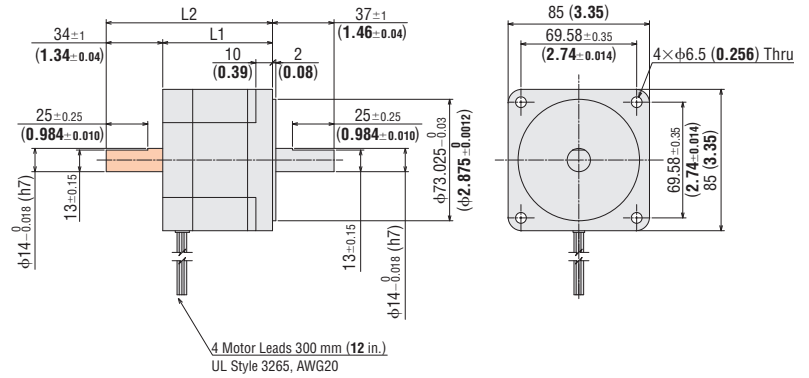

- These dimensions are for double shaft motors.
For single shaft motors, ignore the shaded areas.

Inner Wiring Diagram of Motor

Wiring Diagram No.: Model C⑤

- Refer to page 25 for inner wiring diagram of motor.

Dimensions for Gearhead Unit = mm (in.)

PLE80 Gearhead mm (in.)

3D CAD

Ratio	L1	L2	Mass kg (lb.)
5, 10	60 (2.36)	101.5 (4.0)	2.2 (4.9)
20, 40	77.5 (3.05)	119 (4.7)	2.7 (6.0)

- Use screw set **P00029** (sold separately) to attach Motor and Gearhead.

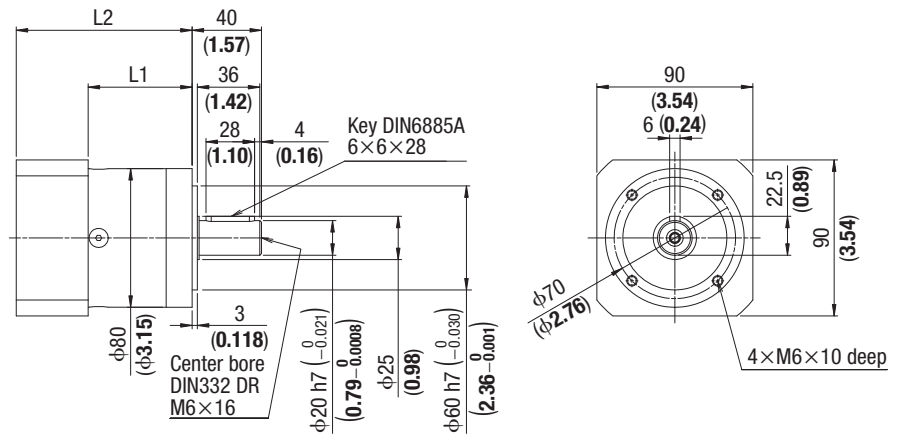

Permissible Radial Load and Permissible Axial Load – PLE Gearhead

Permissible Load

	Permissible load			
	Radial @ center of shaft		Axial	
	N	lb	N	lb
PLE40	200	45	240	54
PLE60	700	157.5	800	180
PLE80	1250	281.25	1600	360

Backlash

	Gear Ratio	Backlash
		arcmin
PLE40	5	15
	10	15
	20	19
	40	19
PLE60	5	10
	10	10
	20	12
	40	12
PLE80	5	7
	10	7
	20	9
	40	9

Inner Wiring Diagram for Motor

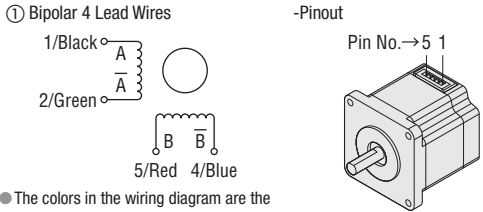
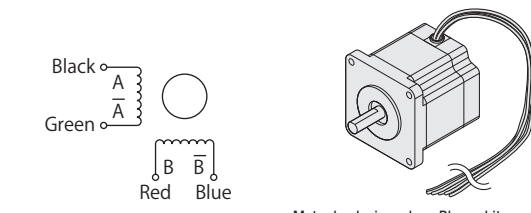
Motor Model Type	Wiring Diagram/Pinout
Model A	<p>① Bipolar 4 Lead Wires -Pinout</p>  <p>● The colors in the wiring diagram are the colors of the separately sold connection cables.</p>
Model C	<p>② Bipolar 4 Lead Wires -Pinout</p>  <p>Motor lead wire colors: Blue, white, red, black, yellow, green</p>

Encoder Specifications

Encoder Product Name	R2EL	R2FL	R2E	R2F
Resolution	200P/R	400P/R	200P/R	400P/R
Output Circuit Type	Line Driver Output*		Voltage Output	
Output Mode	Incremental			
Output Signal	A Phase, B Phase, and Z Phase (3ch)			
Power Supply Voltage	5 VDC ± 10%			
Current	30 mA max.		45 mA max.	

*26C31 or equivalent

Bipolar Driver (sold separately)

CVD Series

These are DC power supply input drivers for stepper motors. The microstep drive function offers superior performance and value and reduces vibration and noise. The driver is equipped with a protective function that enables you to find driver errors early. Running current can be easily set with the digital switch.



Product Number

CVD 2 23 F B R - K

① ② ③ ④ ⑤ ⑥ ⑦

①	Driver Type	
②	2: 1.8° Stepper Motor	
③	Rated Current	
④	Driver Identification	
⑤	Driver Configuration	B: With Installation Plate Blank: Without Installation Plate
⑥	Connector Configuration	R: Right Angle
⑦	Power Supply Input	K: DC Power Supply

● See page 4 for details.

Product Line

Bipolar Driver for 1.8° Stepper Motor

◇ Right Angle Type with Installation Plate

Product Name	List Price
CVD215BR-K	\$135.00
CVD223FBR-K	
CVD228BR-K	
CVD242BR-K	\$150.00
CVD245BR-K	

Included

Type	Connector for Driver Connection	Operating manual
Common to All Types	For CN1 (1 Piece) For CN2 (1 Piece) For CN3 (1 Piece)	1 set

● Driver connection cable sets are available (sold separately). See website for details.

Specifications are subject to change without notice. This catalog was published in February, 2019.

ORIENTAL MOTOR U.S.A. CORP.

Western Sales and Customer Service Center

Tel: (310) 715-3301 Fax: (310) 225-2594

Los Angeles

Tel: (310) 715-3301

San Jose

Tel: (408) 392-9735

Seattle

Tel: (425) 214-7559

Midwest Sales and Customer Service Center

Tel: (847) 871-5900 Fax: (847) 472-2623

Chicago

Tel: (847) 871-5900

Detroit

Tel: (734) 808-0003

Dallas

Tel: (214) 432-3386

Toronto

Tel: (905) 502-5333

Eastern Sales and Customer Service Center

Tel: (781) 848-2426 Fax: (781) 848-2617

Boston

Tel: (781) 848-2426

Charlotte

Tel: (704) 766-1335

New York

Tel: (973) 359-1100

Philadelphia

Tel: (610) 605-3103

Tampa

Tel: (813) 402-4439

Technical Support

Tel: (800) 468-3982 / 8:30 A.M. to 5:00 P.M., P.S.T. (M-F)
7:30 A.M. to 5:00 P.M., C.S.T. (M-F)

E-mail: techsupport@orientalmotor.com

Obtain Specifications, Online Training and Purchase Products at:
www.orientalmotor.com

Copyright ©2018 ORIENTAL MOTOR U.S.A. CORP.

This printed material uses ECF (Elemental Chlorine Free) paper and vegetable oil based inks. This combination is environmentally friendly.

Printed in USA 19P 1K 3.60 #524