

(RoHS) RoHS-Compliant
2-Phase Stepping Motor and Microstep Driver Package

RBK Series

2-phase stepping motor and DC input microstep driver package.
Includes Oriental Motor's proprietary Smooth Drive Function to easily achieve low-vibration operation.



Compact and High Performance Microstep Driver



Standard Type Motor



IP65 Rated Motor

Smooth Drive Function

The Smooth Drive Function is a function that automatically controls the motor's microstep drive operation at the same travel and speed as in the full-step mode, without the operator having to change the speed settings of the driver's pulse input. It enables low-vibration operation available with the microstepping drive to be achieved with the flick of a switch.

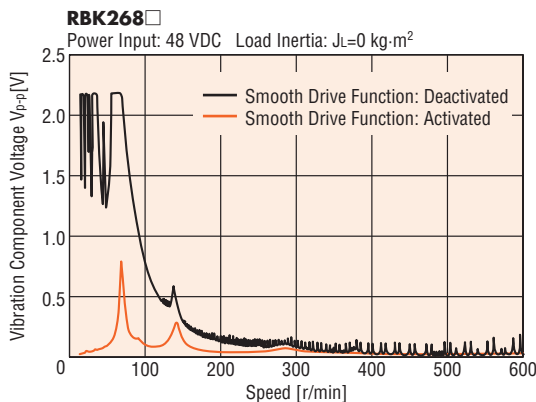

Microstep Function

The microstepping driver electronically divides the basic step angle of the motor ($1.8^\circ/\text{step}$) by up to 128 without the use of a reduction mechanism or other mechanical element. 16 different resolutions levels are available. The available range of resolution settings is 200 ($1.8^\circ/\text{step}$) to 25600 ($0.0140625^\circ/\text{step}$). The step angle can be easily set using the built-in switches on the driver. This function enables low-vibration and low-noise operation.

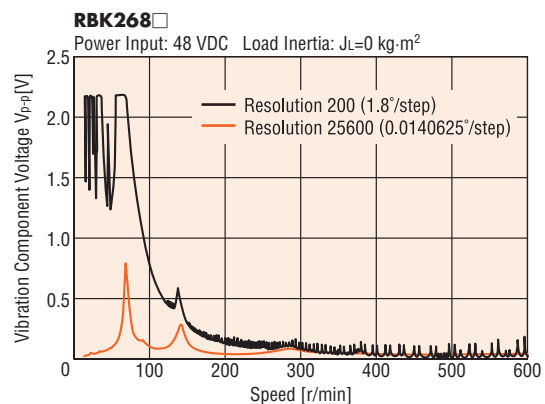

Third Harmonic Waveform Correction Function

This function corrects motor drive current waveforms. It provides improved angle accuracy and reduced vibration.

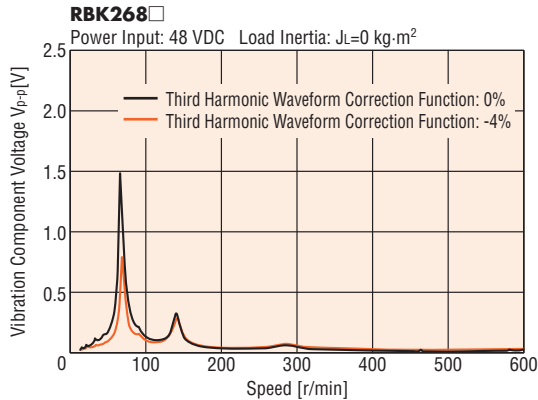

Vibration Suppression Function

This function improves vibrations in the medium speed range of stepping motors. It enables reduced risk of missteps due to vibrations.

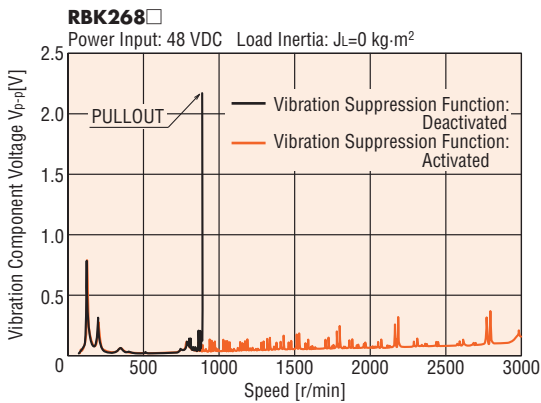

Wide Voltage Range Driver

The **RBK** Series utilizes a constant current driver with a wide voltage range of 20 to 75 VDC and 4.5 A/phase effective value (6.3 A/phase peak value). This enables it to support a wide range of power sources.

- **RBK26** utilizes a constant current driver with a voltage range of 20 to 75 VDC and 4.2 A/phase effective value (5.9 A/phase peak value).

Comparison of Speed – Torque Characteristics

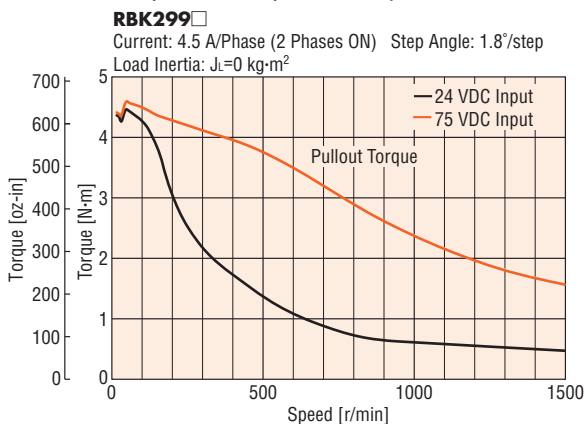

- Raising the power supply voltage enables increased torque during high-speed operation.

Conforming to Major Safety Standards*

The **RBK** Series is UL-recognized and CSA-certified. It also bears the CE Mark as a proof of conformance to the Low Voltage Directives.

- *The **RBK26** (A)(B) and the **RBK29** (A)(B)(A) are currently applying for UL/CSA and EN Standards certification.

RoHS RoHS-Compliant

The **RBK** Series conforms to the RoHS Directive that prohibits the use of six chemical substances including lead and cadmium.

RoHS (Restriction of Hazardous Substances) Directive:

Directive on restriction of the use of certain hazardous substances in electrical and electronic equipment (2002/95/EC). The RoHS Directive prohibits the use of six chemical substances in electrical and electronic products sold in the EU member states. The six controlled substances are: lead, hexavalent chromium, cadmium, mercury and two specific brominated flame-retardants (PBB and PBDE).

The IP65 rated motor conforms to the IP65 standard of ingress protection against dust and water.



Terminal-Block Connection Design

The motor can be wired directly from its terminal block.

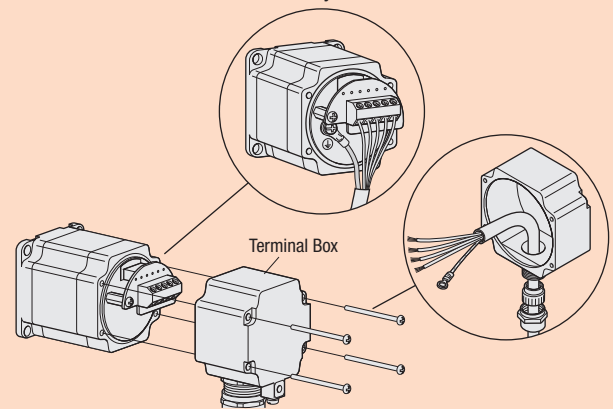

System Configuration

An example of a system configuration with the **EMP400** Series controller.

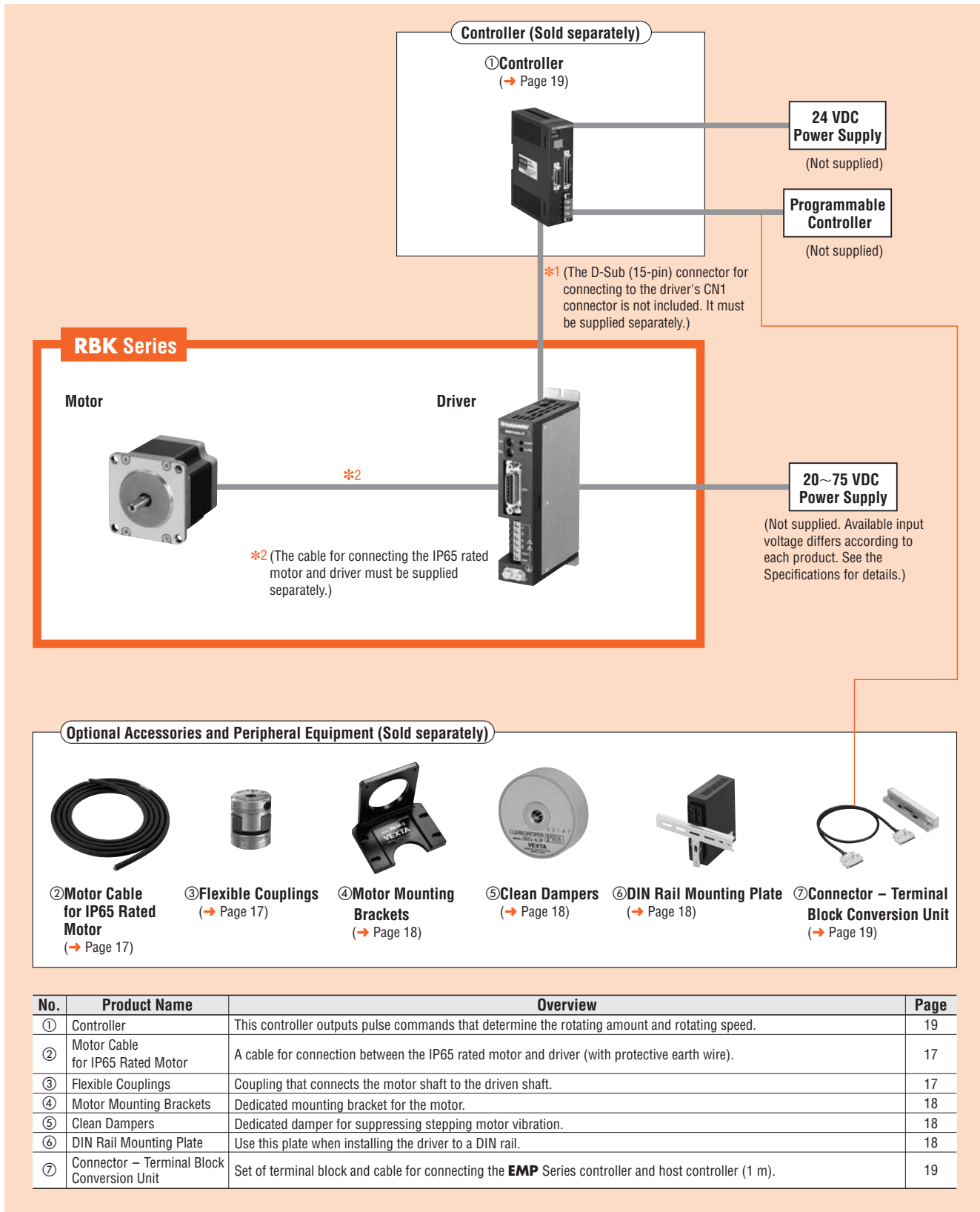

Example of System Configuration

(Sold separately)

RBK Series	+	Controller	Mounting Bracket	Flexible Coupling	Clean Damper	Connector - Terminal Block Conversion Unit
RBK266B		EMP401-1	PAL2P-2	MCS2005F04	D6CL-6.3F	CC50T1

●The system configuration shown above is an example. Other combinations are available.

■ Safety Standards and CE Marking (IP65 rated motor only)

Model	Standards	Certification Body	Standards File No.	CE Marking
Motor	UL 1004, UL 2111 CSA C22.2 No.77 CSA C22.2 No.100	UL	E64199	Low Voltage Directives EMC Directives
	EN 60034-1 EN 60034-5 EN 60950 IEC 60664-1	—	—	
Driver	UL 508C* CSA C22.2 No.14	UL	E171462	Low Voltage Directives EMC Directives
	EN 50178	—	—	

* Maximum Surrounding Air Temperature for UL: 40°C (UL 508C)

● When the system is approved under various safety standards, the model names in the motor and driver names are the approved model names.

● The package is declared voluntary compliance with the EMC Directive. The EMC Directive value changes according to the wiring and layout. Therefore, the final EMC level must be checked with the motor/driver incorporated in the user's equipment.

■ Product Number Code

● Standard Type Motor

RBK 2 6 6 A

① ② ③ ④ ⑤

● IP65 Rated Motor

RBK 2 6 6 T

① ② ③ ④ ⑥

①	Series	RBK: RBK Series
②	2: 2-Phase	
③	Motor Frame Size	6: 56.4 mm (2.22 inch) 9: 85 mm (3.35 inch)
④	Motor Case Length	
⑤	Motor Shaft Type	A: Single Shaft B: Double Shaft
⑥	Motor Classification	

■ Product Line

● Standard Type Motor

Frame Size	Model (Single Shaft)	Model (Double Shaft)
56.4 mm (2.22 inch)	RBK264A	RBK264B
	RBK266A	RBK266B
	RBK268A	RBK268B
85 mm (3.35 inch)	RBK296AA	RBK296BA
	RBK299AA	RBK299BA
	RBK2913AA	RBK2913BA

● IP65 Rated Motor

Frame Size	Model (Single Shaft)	Model (Double Shaft)
56.4 mm (2.22 inch)	RBK264T	—
	RBK266T	—
	RBK268T	—
85 mm (3.35 inch)	RBK296T	—
	RBK299T	—
	RBK2913T	—

The following items are included in each product.

Motor, Driver, Operating Manual

- The cable for connecting the IP65 rated motor and driver, and the D-Sub (15-pin) connector for connecting to the driver's CN1 connector are not included. They must be supplied separately.

● Standard Type Motor

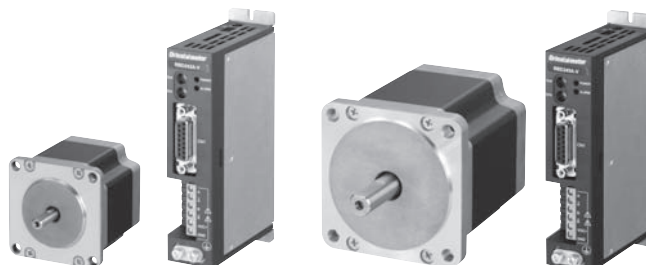

Frame Size 56.4 mm (2.22 inch)

Frame Size 85 mm (3.35 inch)

● IP65 Rated Motor

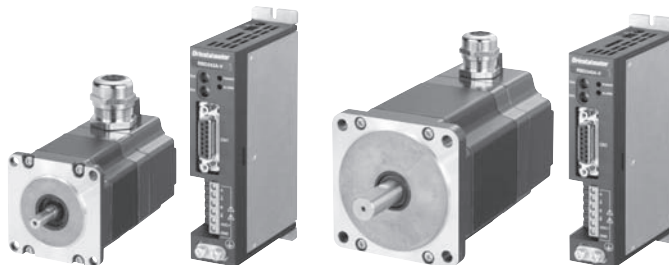

Frame Size 56.4 mm (2.22 inch)

Frame Size 85 mm (3.35 inch)

Standard Type Motor Motor Frame Size 56.4 mm (2.22 inch)

Specifications RoHS

Model	Single Shaft	RBK264A	RBK266A	RBK268A
	Double Shaft	RBK264B	RBK266B	RBK268B
Maximum Holding Torque*	N·m (oz·in)	0.48 (68)	1.17 (166)	1.75 (240)
Rotor Inertia	J: kg·m ² (oz·in ²)	120×10 ⁻⁷ (0.66)	300×10 ⁻⁷ (1.64)	480×10 ⁻⁷ (2.6)
Rated Current	A/Phase	4.2		
Basic Step Angle	1.8°			
Power Source	20~75 VDC 4.9 A			
Excitation Mode	Microstep			
Mass	Motor	kg (lb.)	0.45 (0.99)	0.7 (1.54)
	Driver	kg (lb.)	0.35 (0.77)	
Dimension No.	Motor	①		
	Driver	⑤		

* The holding torque (2-phase excitation) is the maximum holding power (torque) the motor has when power is being supplied but the motor shaft is not rotating (rated current).
The driver's automatic current cutback function at motor standstill reduces maximum holding torque by approximately 50%.

Speed – Torque Characteristics fs: Maximum Starting Frequency

● 24 VDC Input

RBK264A/RBK264B

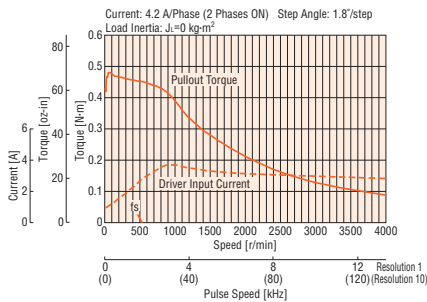

RBK266A/RBK266B

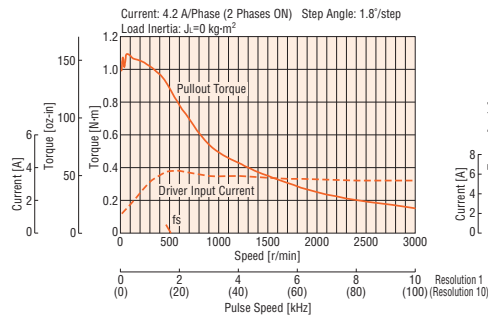

RBK268A/RBK268B

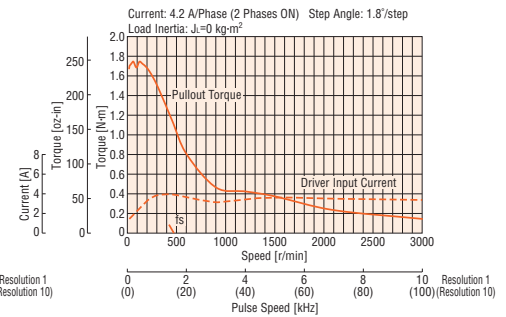

● 48 VDC Input

RBK264A/RBK264B

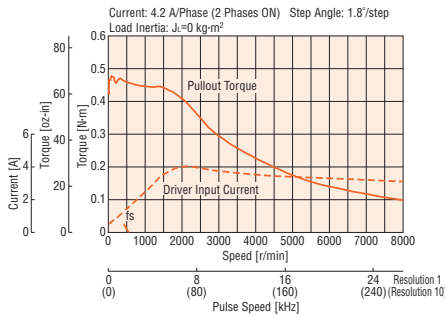

RBK266A/RBK266B

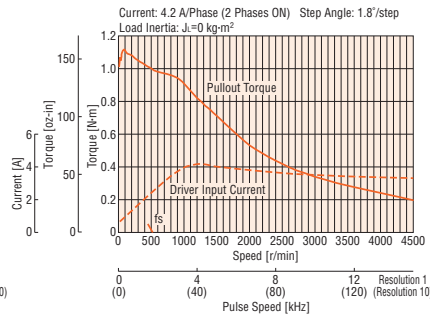

RBK268A/RBK268B

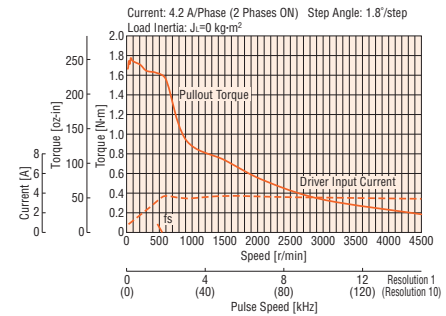

● 75 VDC Input

RBK264A/RBK264B

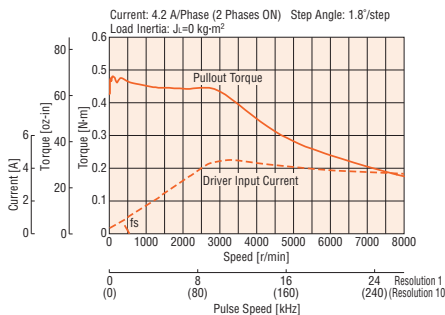

RBK266A/RBK266B

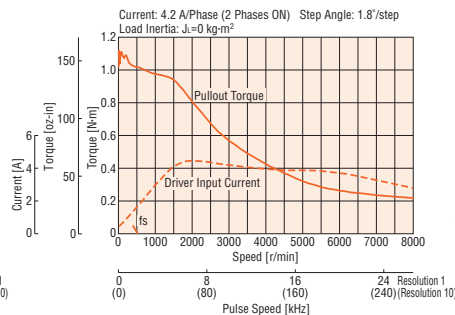

RBK268A/RBK268B

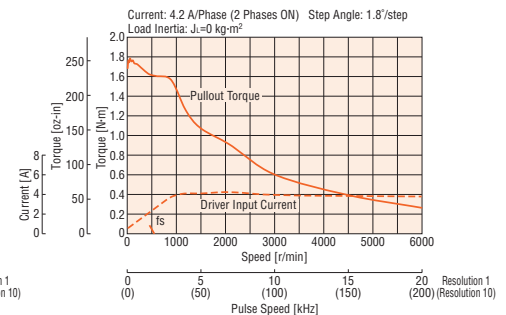

● The pulse input circuit responds to 250 kHz with a pulse duty of 50%.

Notes:

- Pay attention to heat dissipation from motor as there will be a considerable amount of heat under certain conditions. Be sure to keep the temperature of the motor case under 100°C (212°F).
- The driver's automatic current cutback function at motor standstill reduces maximum holding torque by approximately 50%.

Standard Type Motor Motor Frame Size 85 mm (3.35 inch)

Specifications RoHS

Model	Single Shaft	RBK296AA	RBK299AA	RBK2913AA
	Double Shaft	RBK296BA	RBK299BA	RBK2913BA
Maximum Holding Torque*	N-m (oz-in)	2.2 (310)	4.4 (620)	6.6 (930)
Rotor Inertia	J: kg-m ² (oz-in ²)	1400×10 ⁻⁷ (7.7)	2700×10 ⁻⁷ (14.8)	4000×10 ⁻⁷ (22)
Rated Current	A/Phase	4.5		
Basic Step Angle		1.8°		
Power Source		20~75 VDC 5.2 A		
Excitation Mode		Microstep		
Mass	Motor	kg (lb.)	1.7 (3.7)	2.8 (6.2)
	Driver	kg (lb.)	0.35 (0.77)	
Dimension No.	Motor	2		
	Driver	5		

* The holding torque (2-phase excitation) is the maximum holding power (torque) the motor has when power is being supplied but the motor shaft is not rotating (rated current). The driver's automatic current cutback function at motor standstill reduces maximum holding torque by approximately 50%.

Speed – Torque Characteristics fs: Maximum Starting Frequency

● 24 VDC Input

RBK296AA/RBK296BA

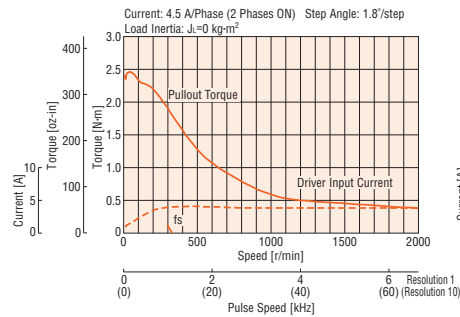

RBK299AA/RBK299BA

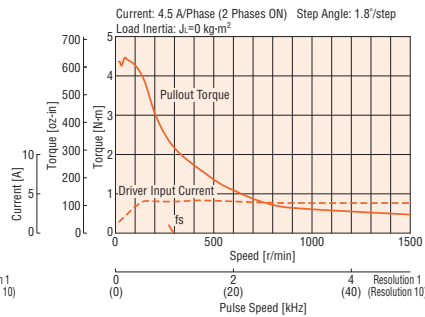

RBK2913AA/RBK2913BA

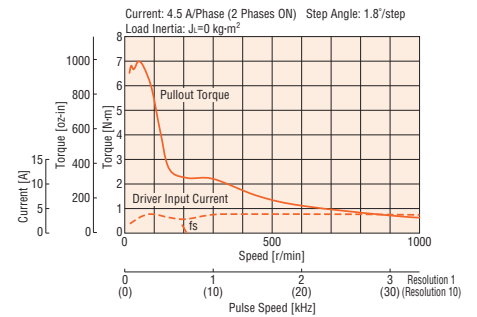

● 48 VDC Input

RBK296AA/RBK296BA

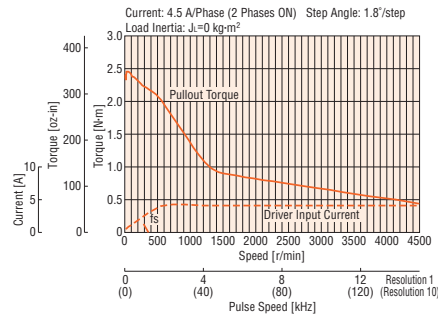

RBK299AA/RBK299BA

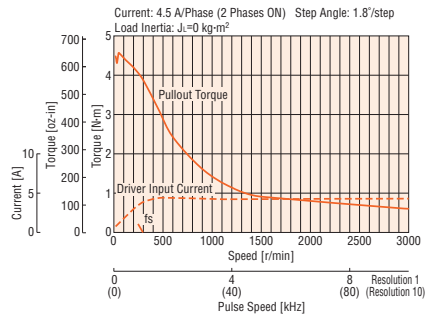

RBK2913AA/RBK2913BA

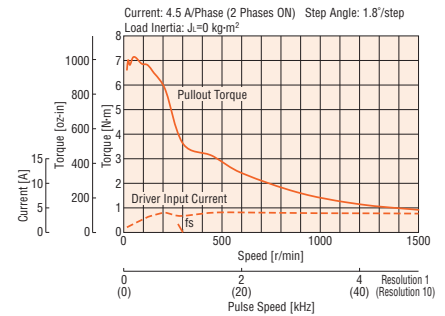

● 75 VDC Input

RBK296AA/RBK296BA

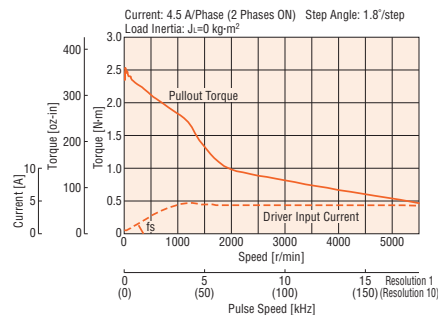

RBK299AA/RBK299BA

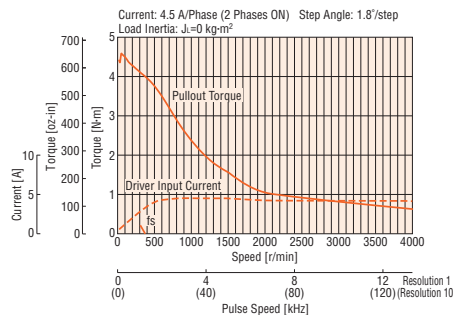

RBK2913AA/RBK2913BA

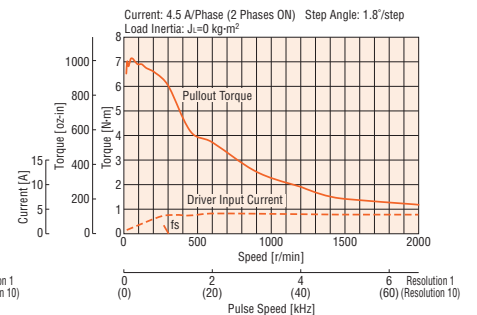

● The pulse input circuit responds to 250 kHz with a pulse duty of 50%.

Notes:

- Pay attention to heat dissipation from motor as there will be a considerable amount of heat under certain conditions. Be sure to keep the temperature of the motor case under 100°C (212°F).
- The driver's automatic current cutback function at motor standstill reduces maximum holding torque by approximately 50%.

IP65 Rated Motor

Motor Frame Size 56.4 mm (2.22 inch)

Specifications RoHS



Model	Single Shaft	RBK264T	RBK266T	RBK268T
Maximum Holding Torque*1	N·m (oz·in)	0.48 (68)	1.17 (166)	1.75 (240)
Rotor Inertia	J: kg·m ² (oz·in ²)	120×10 ⁻⁷ (0.66)	300×10 ⁻⁷ (1.64)	480×10 ⁻⁷ (2.6)
Rated Current	A/Phase		4.2	
Basic Step Angle			1.8°	
Power Source			20~75 VDC 4.9 A	
Excitation Mode			Microstep	
Degree of Protection			Motor: IP65*2 Driver: IP20	
Mass	Motor kg (lb.) Driver kg (lb.)	0.6 (1.32)	0.9 (1.98) 0.35 (0.77)	1.2 (2.6)
Dimension No.	Motor Driver		③ ⑤	

*1 The holding torque (2-phase excitation) is the maximum holding power (torque) the motor has when power is being supplied but the motor shaft is not rotating (rated current).
The driver's automatic current cutback function at motor standstill reduces maximum holding torque by approximately 50%.

*2 Excluding the gap between the shaft and the flange.

Speed – Torque Characteristics fs: Maximum Starting Frequency

● 24 VDC Input

RBK264T

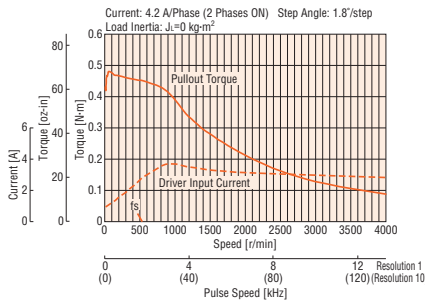

RBK266T

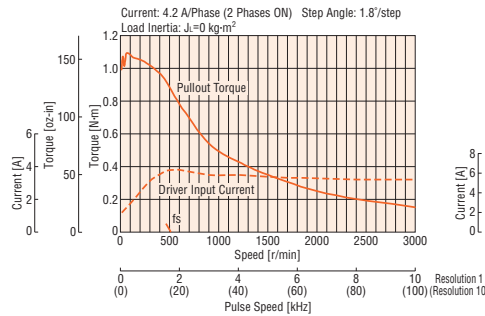

RBK268T

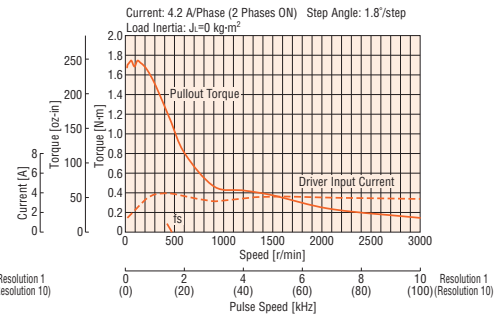

● 48 VDC Input

RBK264T

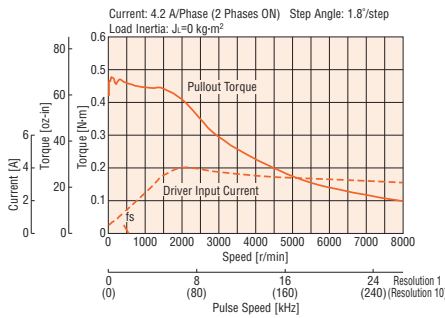

RBK266T

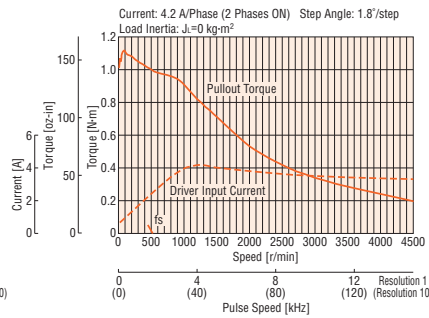

RBK268T

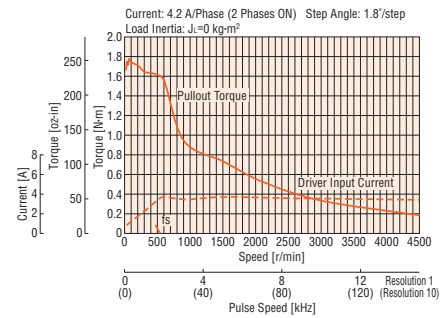

● 75 VDC Input

RBK264T

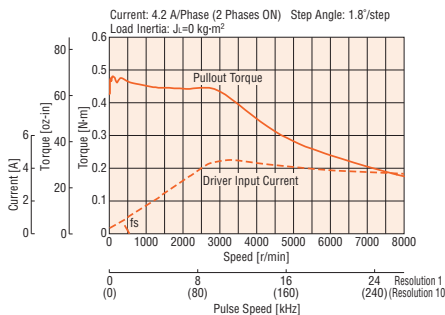

RBK266T

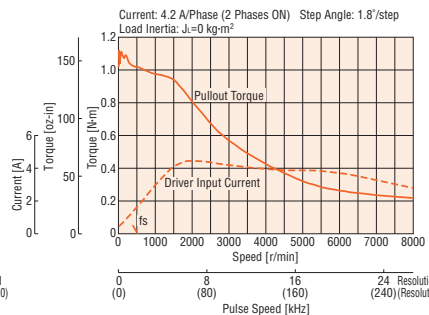

RBK268T

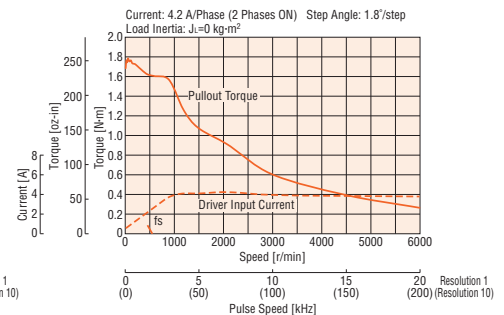

● The pulse input circuit responds to 250 kHz with a pulse duty of 50%.

Notes:

● Pay attention to heat dissipation from motor as there will be a considerable amount of heat under certain conditions. Be sure to keep the temperature of the motor case under 100°C (212°F).
[Under 75°C (167°F) is required to comply with UL or CSA Standards as the motor is recognized as insulation class A.]

● The driver's automatic current cutback function at motor standstill reduces maximum holding torque by approximately 50%.

IP65 Rated Motor Motor Frame Size 85 mm (3.35 inch)

Specifications RoHS



Model	Single Shaft	RBK296T	RBK299T	RBK2913T
Maximum Holding Torque*1	N·m (oz·in)	2.2 (310)	4.4 (620)	6.6 (930)
Rotor Inertia	J: kg·m ² (oz·in ²)	1400×10 ⁻⁷ (7.7)	2700×10 ⁻⁷ (14.8)	4000×10 ⁻⁷ (22)
Rated Current	A/Phase		4.5	
Basic Step Angle			1.8°	
Power Source			20~75 VDC 5.2 A	
Excitation Mode			Microstep	
Degree of Protection			Motor: IP65*2 Driver: IP20	
Mass	Motor	kg (lb.)	2.1 (4.6)	3.2 (7)
	Driver	kg (lb.)		0.35 (0.77)
Dimension No.	Motor		4	
	Driver		5	

- *1 The holding torque (2-phase excitation) is the maximum holding power (torque) the motor has when power is being supplied but the motor shaft is not rotating (rated current). The driver's automatic current cutback function at motor standstill reduces maximum holding torque by approximately 50%.
- *2 Excluding the gap between the shaft and the flange.

Speed – Torque Characteristics fs: Maximum Starting Frequency

24 VDC Input

RBK296T

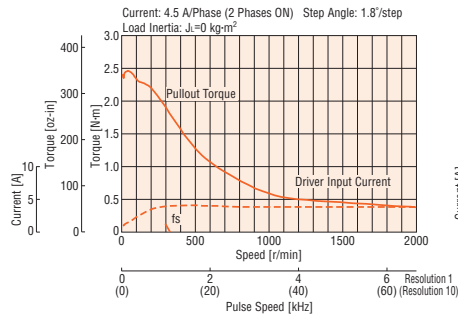

RBK299T

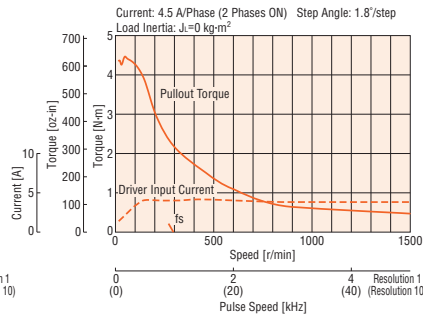

RBK2913T

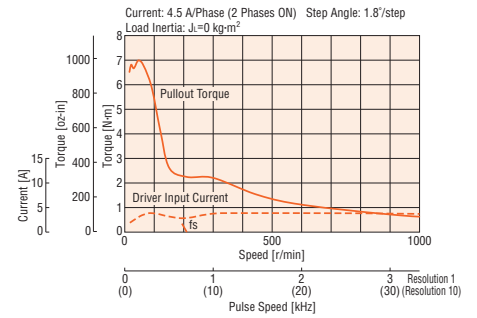

48 VDC Input

RBK296T

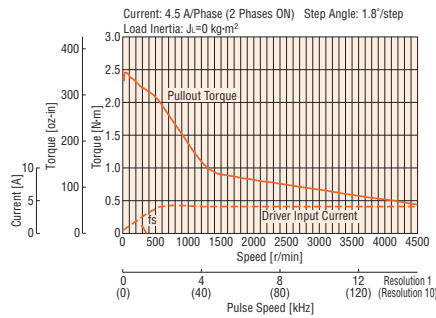

RBK299T

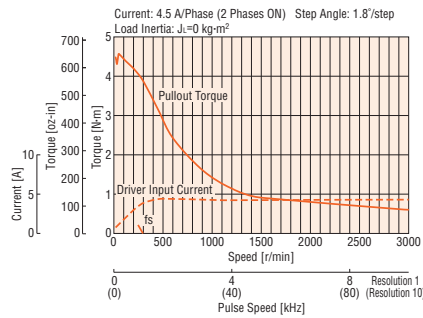

RBK2913T

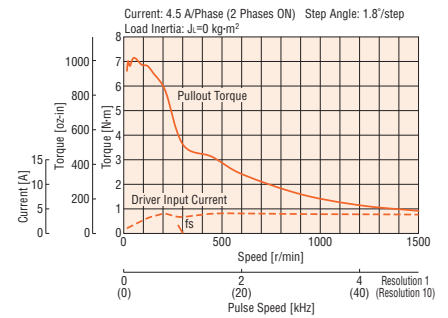

75 VDC Input

RBK296T

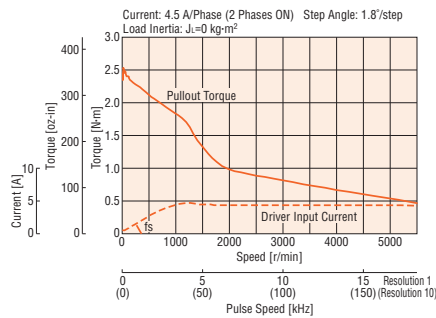

RBK299T

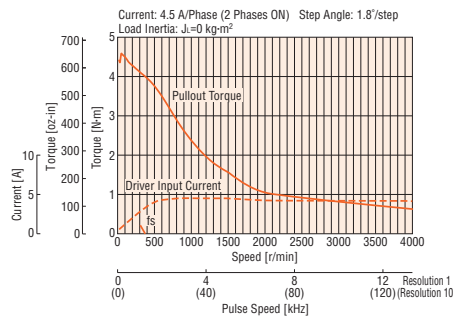

RBK2913T

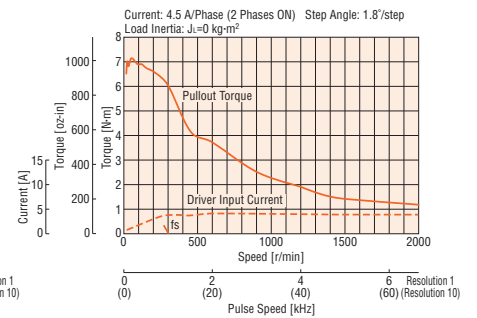

● The pulse input circuit responds to 250 kHz with a pulse duty of 50%.

Notes:

- Pay attention to heat dissipation from motor as there will be a considerable amount of heat under certain conditions. Be sure to keep the temperature of the motor case under 100°C (212°F). [Under 75°C (167°F) is required to comply with UL or CSA Standards as the motor is recognized as insulation class A.]
- The driver's automatic current cutback function at motor standstill reduces maximum holding torque by approximately 50%.

Driver Specifications

Input Signals	Input Mode	Photocoupler Input PLS signal, DIR signal: Input resistance 200 Ω Input current 5~20 mA Photocoupler "ON": 3~5.25 V Photocoupler "OFF": 0~1 V (Line driver input: -5.25~1 V) (Voltage between terminals) PLS24 signal, DIR24 signal: Input resistance 2.7 kΩ Input current 5~20 mA Photocoupler "ON": 21.6~26.4 V Photocoupler "OFF": 0~1 V (Voltage between terminals) All windings off signal, Step angle select signal: Input resistance 3 kΩ Input current 20 mA or less Photocoupler "ON": 4.5~26.4 V Photocoupler "OFF": 0~1 V (Voltage between terminals)
	Pulse Signal	Operation command pulse signal Negative logic pulse input Pulse width: 2 μs minimum (Line driver input: 1 μs minimum), Pulse rise/fall: 1 μs maximum Pulse duty 50% and below The motor moves one step when the pulse input is switched from photocoupler ON to OFF. Maximum input pulse frequency 250 kHz (Line driver input: 500 kHz) (When the pulse duty is 50%)
	Rotation Direction Signal	Rotation direction signal, Photocoupler "ON": CW, Photocoupler "OFF": CCW Negative logic pulse input
	All Windings Off Signal	When in the "photocoupler ON" state, the output current to the motor is cut off and the motor shaft can be rotated manually. When in the "photocoupler OFF" state, the output current to the motor is turned on.
	Step Angle Select Signal	When in the "photocoupler ON" state, the motor operates with the basic step angle, regardless of the setting of the step angle setting switch. When in the "photocoupler OFF" state, the motor operates with the step angle set with the step angle setting switch.
Output Signals	Output Mode	Photocoupler, Open-collector output External use condition: 30 VDC maximum, 10 mA maximum
	Current Cutback Signal	When the automatic current cutback function is activated, the output turns on. (Photocoupler "ON")
	Alarm Signal	When one of the driver's protective functions is activated, the output turns off. (Photocoupler "OFF")
	Excitation Timing Signal	The signal is output every time the excitation sequence returns to the initial stage "0." (Photocoupler "ON") Example) 1.8°/step (1 resolution): Signal output every 4 pulses 0.45°/step (4 resolutions): Signal output every 16 pulses
Functions	Third Harmonic Waveform Correction, Smooth Drive, Vibration Suppression, Automatic Current Cutback, Step Angle Select, All Windings Off, Excitation Timing	
Cooling Method	Natural ventilation	

General Specifications

Specifications		Motor	Driver
Insulation Class		Standard type motor: Class B [130°C (266°F)] IP65 rated motor: Class B [130°C (266°F)] [Recognized as class A 105°C (221°F) by UL/CSA Standards]	-
Insulation Resistance		100 MΩ or more when 500 VDC megger is applied between the windings and the case under normal ambient temperature and humidity.	-
Dielectric Strength		Sufficient to withstand 1.0 kV at 50 Hz or 60 Hz applied between the windings and the case for 1 minute under normal ambient temperature and humidity. (1.5 kVDC for IP65 rated motor)	-
Operating Environment (In Operation)	Ambient Temperature	-10~+50°C (-14~+122°F) (non-freezing)	0~+40°C (32~104°F) (non-freezing)
	Ambient Humidity	85% or less (non-condensing)	
	Atmosphere	Standard type motor: No exposed to corrosive gases, dust, water or oil. IP65 rated motor: No exposed to corrosive gases.	
Temperature Rise		Temperature rise of the windings is 80°C (176°F) or less measured by the resistance change method. (at rated current, at standstill, two phases energized) RBK26□ : when equipped with an aluminum heat sink of 250×250 mm, 10 mm thick (9.84×9.84 inch, 0.39 inch thick) When using the RBK26□T or the RBK29□T as a UL or CSA recognized component, make sure the temperature rise of the windings is 50°C (122°F) or less, by mounting the motor to a heat sink (material: aluminum) of the following size. RBK26□T : 400×400 mm, 10 mm thick (15.75×15.75 inch, 0.39 inch thick) RBK29□T : 200×200 mm, 10 mm thick (7.87×7.87 inch, 0.39 inch thick)	-
Stop Position Accuracy*1		±3 arc minutes (±0.05°)	-
Shaft Runout		0.05 mm (0.002 inch) T.I.R.*4	-
Radial Play*2		0.025 mm (0.001 inch) max. of 5 N (1.12 lb.)	-
Axial Play*3		0.075 mm (0.003 inch) max. of 10 N (2.2 lb.)	-
Concentricity		0.075 mm (0.003 inch) T.I.R.*4	-
Perpendicularity		0.075 mm (0.003 inch) T.I.R.*4	-

*1 This value is for full step under no load. (The value changes with the size of the load.)

*2 Radial Play: Displacement in shaft position in the radial direction, when a 5 N (1.12 lb.) load is applied in the vertical direction to the tip of the motor's shaft.

*3 Axial Play: Displacement in shaft position in the axial direction, when a 10 N (2.2 lb.) load is applied to the motor's shaft in the axial direction.

*4 T.I.R. (Total Indicator Reading): The total dial gauge reading when the measurement section is rotated one revolution centered on the reference axis center.

Note:

- Do not measure insulation resistance or perform the dielectric strength test while the motor and driver are connected.

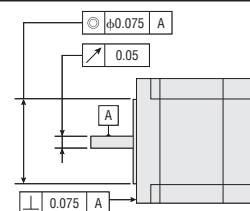

Permissible Overhung Load and Permissible Thrust Load

Type	Model	Permissible Overhung Load [N (lb.)] Distance from Shaft End [mm (inch)]					Permissible Thrust Load*
		0	5 (0.2)	10 (0.39)	15 (0.59)	20 (0.79)	
Standard Type Motor	RBK264 □						0.45 (0.99)
	RBK266 □	54 (12.1)	67 (15)	89 (20)	130 (29)	—	0.7 (1.54)
	RBK268 □						1 (2.2)
	RBK296 □ A	260 (58)	290 (65)	340 (76)	390 (87)	480 (108)	1.7 (3.7)
	RBK299 □ A						2.8 (6.2)
	RBK2913 □ A						3.8 (8.4)
IP65 Rated Motor	RBK264T						0.6 (1.32)
	RBK266T	54 (12.1)	67 (15)	89 (20)	130 (29)	—	0.9 (1.98)
	RBK268T						1.2 (2.6)
	RBK296T	260 (58)	290 (65)	340 (76)	390 (87)	480 (108)	2.1 (4.6)
	RBK299T						3.2 (7)
	RBK2913T						4.3 (9.5)

* The permissible thrust load is equal to the motor mass [unit: kg (lb.)]. Make sure the thrust load is no greater than the motor mass.

● Enter **A** (single shaft) or **B** (double shaft) in the box (□) within the model name.

Dimensions [Unit = mm (inch)]

● Motor

◇ Standard Type Motor

1 □ 56.4 mm (□ 2.22 inch)

Model	Motor Model	L1 [mm (inch)]	L2 [mm (inch)]	Mass [kg (lb.)]	DXF
RBK264A	PK264DA	39 (1.54)	—	0.45 (0.99)	B084
RBK264B	PK264DB		55 (2.17)		
RBK266A	PK266DA	54 (2.13)	—	0.7 (1.54)	B085
RBK266B	PK266DB		70 (2.76)		
RBK268A	PK268DA	76 (2.99)	—	1.0 (2.2)	B086
RBK268B	PK268DB		92 (3.62)		

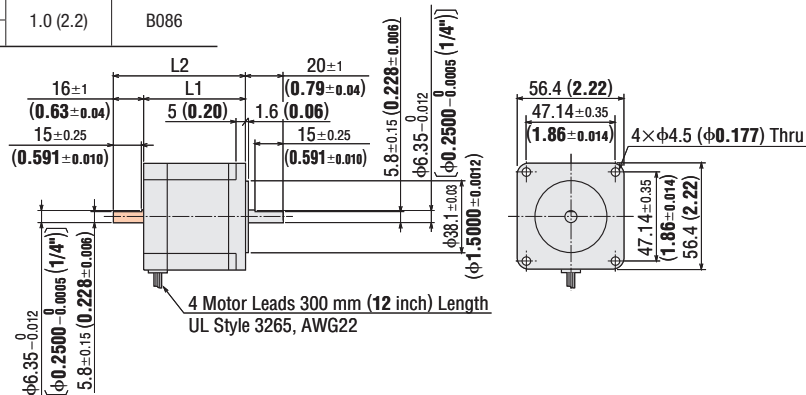

2 □ 85 mm (□ 3.35 inch)

Model	Motor Model	L1 [mm (inch)]	L2 [mm (inch)]	Mass [kg (lb.)]	DXF
RBK296AA	PK296DAA	66 (2.6)	—	1.7 (3.7)	B122U
RBK296BA	PK296DBA		100 (3.94)		
RBK299AA	PK299DAA	96 (3.78)	—	2.8 (6.2)	B123U
RBK299BA	PK299DBA		130 (5.12)		
RBK2913AA	PK2913DAA	126 (4.96)	—	3.8 (8.4)	B124U
RBK2913BA	PK2913DBA		160 (6.3)		

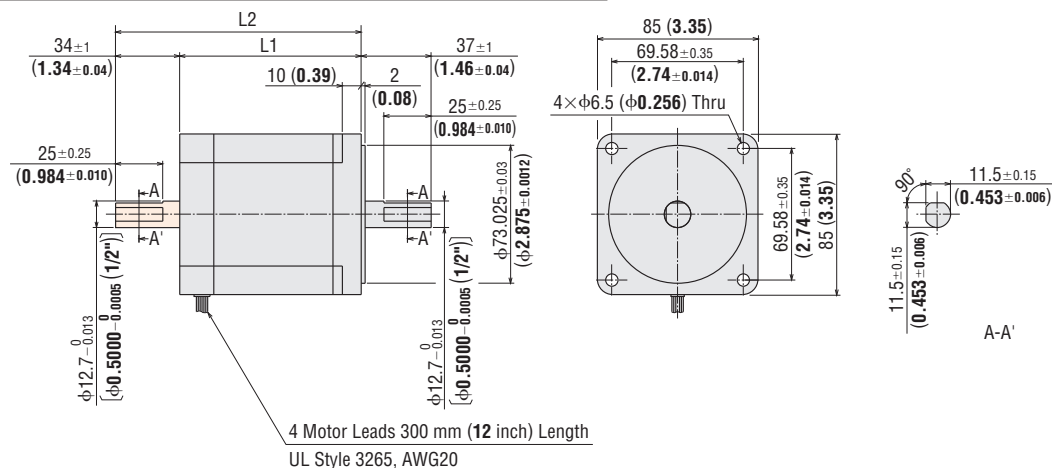

Connection and Operation

Names and Functions of Driver Parts

(Top)



② Function Switch, Motor Stop Current Switch

① Signal Monitor Displays

◇ LED Indicators

Indication	Color	Function
POWER	Green	Power input display
ALARM	Red	Alarm signal output display

◇ Alarm

Blink Count	Function	Condition
2	Overheat	The driver temperature exceeded the specified value.
3	Overvoltage	The primary voltage of the driver's inverter exceeded the permissible value.
5	Overcurrent	An excessive current has flowed to the driver's inverter.

② Function Switch, Motor Stop Current Switch

Indication	Switch Name	Function
SW1	Third Harmonic Waveform Correction Function Select Switch	A function that provides improved angle accuracy and reduced vibrations by optimizing the motor drive current waveforms. You can set the correction value using the select switch.
SW2-1	Smooth Drive Function Switch	Low vibration and low noise operation are available even in the low speed range without changing the step angle setting. The function can be set and deactivated with this switch.
SW2-2	Vibration Suppression Function Select Switch	A function that provides reduced vibrations at medium speed operation. The function can be set or deactivated with this switch.
SW2-3	Not used.	—
SW2-4	Motor Stop Current Switch	For adjusting the current at motor standstill

③ Motor Run Current Switch

Indication	Switch Name	Function
RUN	Motor Run Current Switch	For adjusting the motor running current

⑤ Input/Output Signals

Indication	Input/Output	Pin No.	Signal	Content	Function
CN1*	Input	1	PLS+	Pulse Signal	Operation command pulse signal
		2	PLS24+		
		9	PLS-		
		3	DIR+	Rotation Direction Signal	
		10	DIR24+		
		11	DIR-		
		4	AWO	All Windings Off Signal	
	12	CS	Step Angle Select Signal	Operates with the basic step angle, regardless of the DATA setting.	
	5	IN-COM	Input Common	Input common for the All Windings Off signal and Step Angle Select signal.	
	Output	13	CD+	Current Cutback Signal	Outputs a signal when the automatic current cutback function activates.
		6	CD-		
		14	ALM+	Alarm Signal	
		7	ALM-		
		15	TIM+	Excitation Timing Signal	
		8	TIM-		

* The cable for connecting the IP65 rated motor and driver, and the D-Sub (15-pin) connector for connecting to the driver's CN1 connector are not included. They must be supplied separately.

Description of input/output signals → Page 15

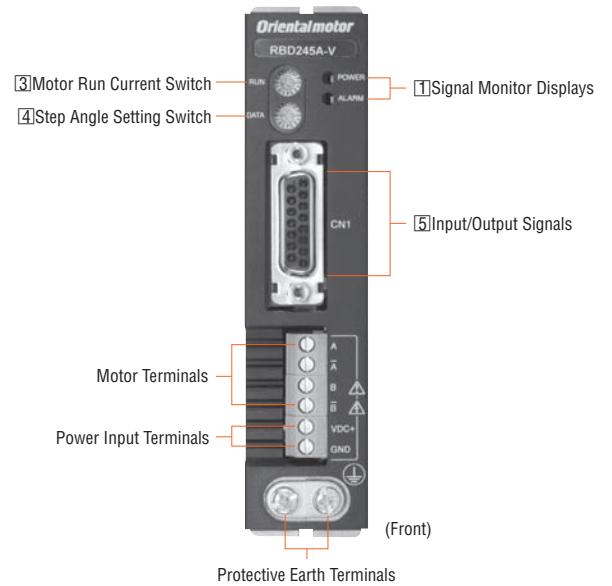

④ Step Angle Setting Switch

Indication	Switch Name	Function
DATA	Step Angle Setting Switch	The switch can be set to the desired resolution from the 16 resolution levels.

Step Angle Setting Switch	Microstep/Step	Resolution	Step Angle
0	1	200	1.8°
1	2	400	0.9°
2	4	800	0.45°
3	5	1000	0.36°
4	8	1600	0.225°
5	9	1800	0.2°
6	10	2000	0.18°
7	16	3200	0.1125°
8	18	3600	0.1°
9	20	4000	0.09°
A	32	6400	0.05625°
B	36	7200	0.05°
C	40	8000	0.045°
D	64	12800	0.028125°
E	80	16000	0.0225°
F	128	25600	0.0140625°

● The step angle set with the step angle setting switch is enabled when the step angle select (CS) signal input turns off.

● Do not change the step angle select signal input or step angle setting switch while the motor is running. This may cause the motor to misstep and stop. Set the step angle setting switch when the step angle select signal input is turned off, and the excitation timing output is turned on.

● Connection Diagrams

◇ 5 VDC Connection or Line Driver Input

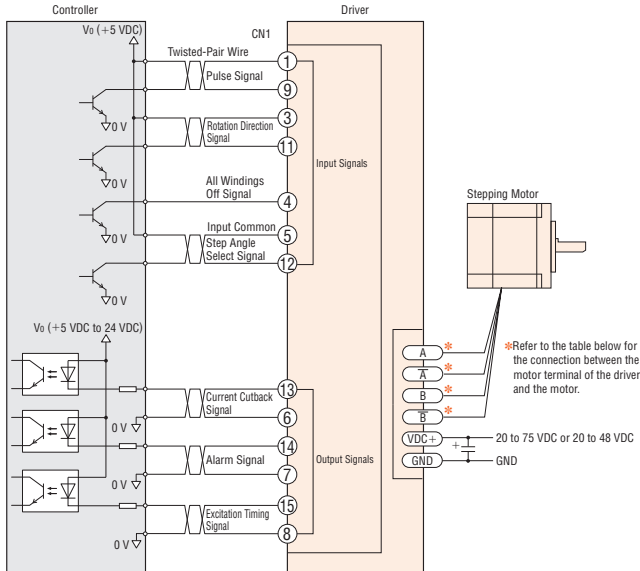

◇ 24 VDC Connection

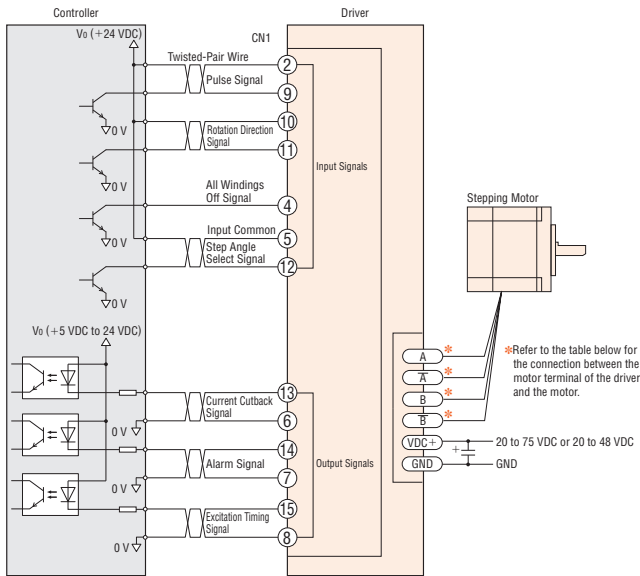

◇ Pulse (PLS) and Rotation Direction (DIR) Input Signal Connections

You can select either 5 VDC or 24 VDC as the signal voltage for PLS input and DIR input. Line driver input is also available. The pin No. to connect differs according to the signal voltage.

◇ All Windings Off (AWO) and Step Angle Select (CS) Input Signal Connections

You can select either 5 VDC or 24 VDC as the signal voltage. The pin No. to connect is the same for 5 VDC and 24 VDC.

◇ Connecting Output Signal

Keep the output signal voltage and current below 30 VDC and 10 mA respectively.

◇ Power Supply

Use a power supply that can supply sufficient input current. When power supply capacity is insufficient, a decrease in motor output can cause the following malfunctions:

- Motor does not operate properly at high-speed.
- Slow motor startup and stopping.

◇ Notes on Wiring

- Use twisted-pair wires of AWG26 (0.14 mm²) or thicker and 2 m (6.6 feet) or less in length for the signal lines.
- Note that as the length of the pulse signal line increases, the maximum transmission frequency decreases.
- Use wires of AWG18 (0.75 mm²) or thicker for motor lines (when extended), power supply lines, and protective earthing line.
- To ground the driver, lead the ground conductor from the protective earth terminal (M4) and connect the ground conductor to provide a common ground point.
- Signal lines should be kept at least 2 cm (0.79 inch) away from power lines (power supply lines and motor lines). Do not bind the signal lines and power lines together.
- If noise generated by the motor cable or power cable becomes a problem due to the wiring and layout, shield the cables or use ferrite cores.
- Incorrect connection of DC power input will lead to driver damage. Make sure that the polarity is correct before turning power on.
- The cable for connecting the IP65 rated motor and driver, and the D-Sub (15-pin) connector for connecting to the driver's CN1 connector are not included. They must be supplied separately.

•Driver Motor Terminals and Motor Leads/Motor Terminal Blocks

Signal Name	Signal	Standard Type Motor	IP65 Rated Motor	
			Terminal Block No. for RBK26□	Terminal Block No. for RBK29□
A	A-phase output	Black	2	1
\bar{A}	\bar{A} -phase output	Green	3	4
B	B-phase output	Red	4	5
\bar{B}	\bar{B} -phase output	Blue	5	8

◇ IP65 Rated Motor Connections

RBK264T, RBK266T, RBK268T

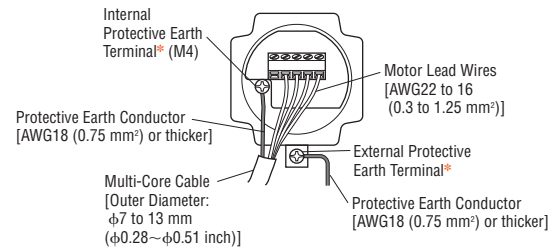

* Connect either the internal protective earth terminal or external protective earth terminal to the ground.

Connect motor lead wires to the terminals 2 to 5.

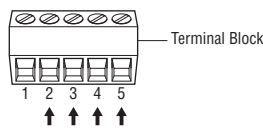

RBK296T, RBK299T, RBK2913T

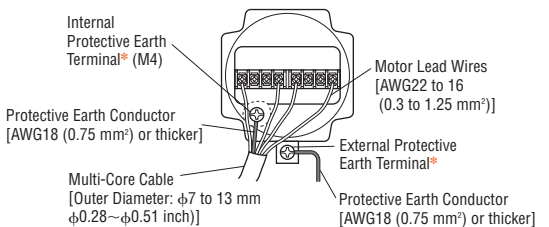

* Connect either the internal protective earth terminal or external protective earth terminal to the ground.

Terminals 1, 4, 5, and 8 are used. Terminals 2, 3, 6, and 7 are not used. Do not connect anything to them.

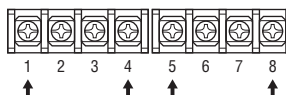

● Description of Input/Output Signals

Indication of Input/Output Signal "ON""OFF"

Input (Output) "ON" indicates that the current is sent into the photocoupler (transistor) inside the driver. Input (Output) "OFF" indicates that the current is not sent into the photocoupler (transistor) inside the driver. The input/output remains "OFF" if nothing is connected.

Photocoupler OFF ON

Pulse (PLS), Rotation Direction (DIR) Input Signal

You can select either 5 VDC or 24 VDC as the signal voltage for PLS input and DIR input. Line driver input is also available.

◇ Input Circuit and Sample Connection

● 5 VDC Connection

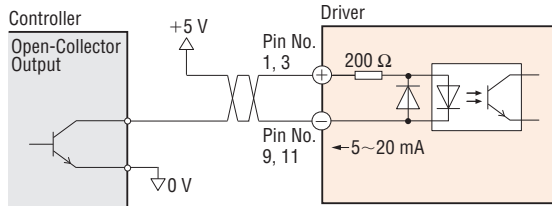

● 24 VDC Connection

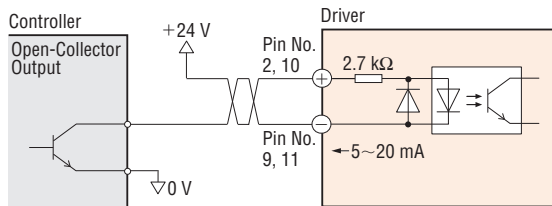

● Line Driver Input

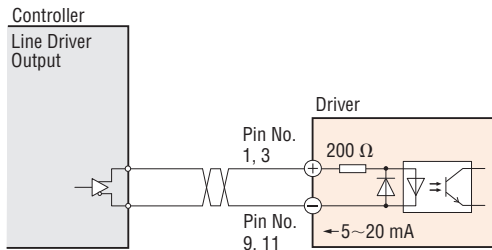

◇ Pulse Waveform

● 5 VDC or 24 VDC Connection

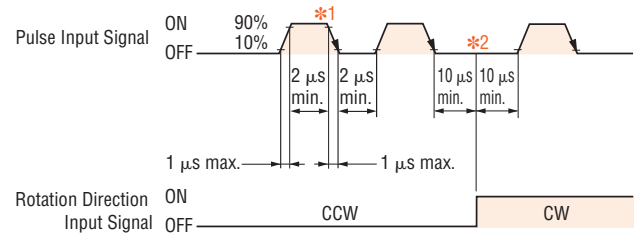

● Pulse duty: 50% and below

● Line Driver Input

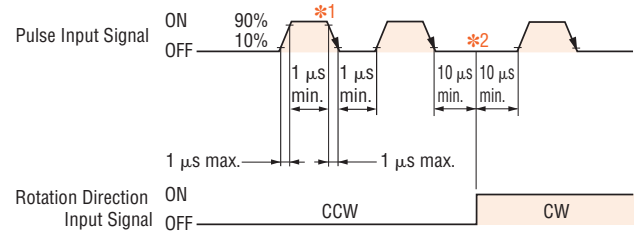

● Pulse duty: 50% and below

- *1 The shaded area indicates when the photocoupler diode is ON. The motor moves when the photocoupler state changes from ON to OFF.
- *2 The minimum interval time when changing rotation direction 10 μs is shown as a response time of circuit. This value varies greatly depending on the motor type and load inertia.

◇ Pulse Signal Characteristics

- Keep the pulse signal at the "photocoupler OFF" state when no pulses are being input.
- Leave the pulse signal at rest ("photocoupler OFF") when changing rotation directions.

All Windings Off (AWO), Step Angle Select (CS) Input Signal

◇ Input Circuit and Sample Connection

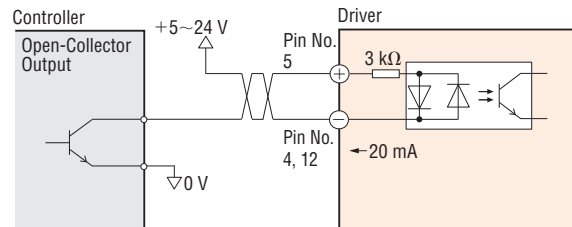

◇ All Windings Off (AWO) Input Signal

- Inputting this signal puts the motor in a non-excitation (free) state.
- This signal is used when turning the motor by external force or manual home position is desired. The photocoupler must be "OFF" when operating the motor.

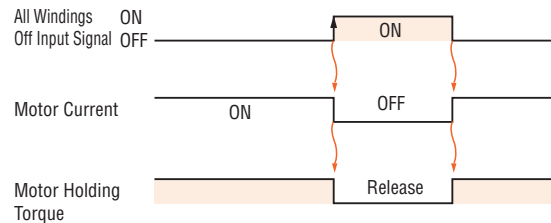

- Switching the "All Windings Off" signal from "photocoupler ON" to "photocoupler OFF" does not alter the excitation sequence. When the motor shaft is manually adjusted with the "AWO" signal input, the shaft will shift up to $\pm 3.6^\circ$ from the position set after the "AWO" signal is released.

◇ Step Angle Select (CS) Input Signal

- When the signal is at "photocoupler ON," the motor operates with the basic step angle, regardless of the setting of the step angle setting switch. When the signal is at "photocoupler OFF," the motor operates with the step angle set with the step angle setting switch.
- When changing the step angle, make sure the "Excitation Timing" signal output is turned on and the motor is at standstill.

Current Cutback (CD), Alarm (ALM), Timing (TIM) Output Signal

◇ Output Circuit and Sample Connection

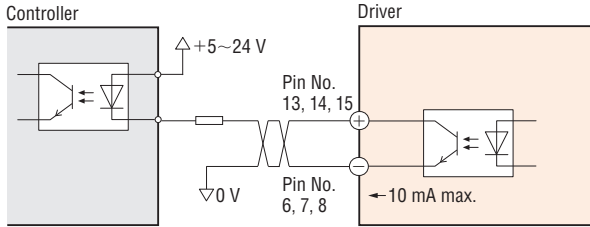

◇ Current Cutback (CD) Output Signal

- When the automatic current cutback function is activated, the CD output turns on.

◇ Alarm (ALM) Output Signal

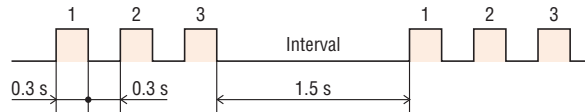

- When the motor is running, if the driver overheat, overvoltage, or overcurrent protective function is detected, the ALM output turns off, and the ALARM LED of the driver flashes. The current to the motor is also cut off to stop the motor.
- You can count the number of times the ALARM LED flashes to confirm which protective function is activated.
- This signal normally stays on, but turns off when a protective function is activated.

◇ Timing (TIM) Output Signal

- The "Excitation Timing" signal is output to indicate when the motor excitation (current flowing through the winding) is in the initial stage (step "0" at power up).
 - The "Excitation Timing" signal is output simultaneously with a pulse input each time the excitation sequence returns to step "0." The excitation sequence will complete one cycle for every 7.2° rotation of the motor output shaft.
- Resolution 1: Signal is output once every 4 pulses.
Resolution 4: Signal is output once every 16 pulses.

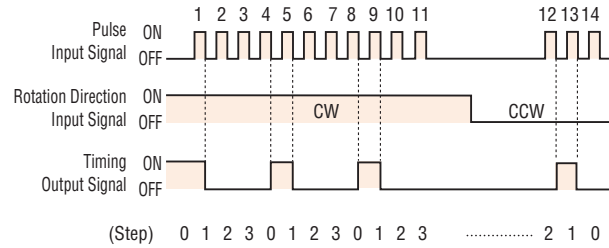

Notes:

- When power is turned ON, the excitation sequence is reset to step "0" and the "Excitation Timing" signal is output.
- When using the "Excitation Timing" output signal, operate the motor so that its output shaft stops at an integral multiple of 7.2°.

● Timing Chart

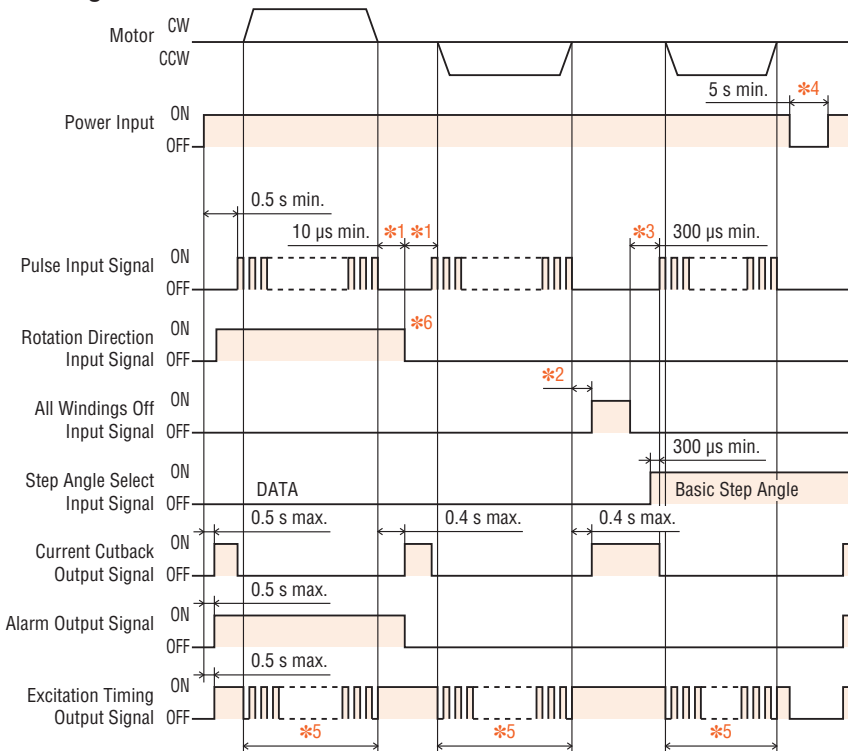

- *1 The switching time to change direction 10 μs is shown as the response time of the circuit. The motor may need more time.
- *2 Depends on load inertia, load torque, and starting frequency.
- *3 Never input a step pulse signal immediately after switching the "All Windings Off" input signal to the "OFF" state. The motor may not start.
- *4 To cycle the power, turn off the power and then wait for at least five seconds after the POWER LED has turned off.
- *5 "Excitation Timing" signal is output once every 7.2° rotation of the motor output shaft.
- *6 The minimum interval time needed for switching the direction of rotation will vary, depending on the operating speed and size of the load. Do not shorten the interval time any more than is necessary.

The shaded section indicates that the photocoupler diode is emitting light.

List of Motor and Driver Combinations

Model names for motor and driver combinations are shown below.

Standard Type Motor

Model	Motor Model	Driver Model
RBK264 □	PK264D□	RBD242A-V
RBK266 □	PK266D□	RBD242A-V
RBK268 □	PK268D□	RBD242A-V
RBK296 □ A	PK296D□ A	RBD245A-V
RBK299 □ A	PK299D□ A	RBD245A-V
RBK2913 □ A	PK2913D□ A	RBD245A-V

Enter **A** (single shaft) or **B** (double shaft) in the box (□) within the model name.

IP65 Rated Motor

Model	Motor Model	Driver Model
RBK264T	PK264D1T	RBD242A-V
RBK266T	PK266D1T	RBD242A-V
RBK268T	PK268D1T	RBD242A-V
RBK296T	PK296DT	RBD245A-V
RBK299T	PK299DT	RBD245A-V
RBK2913T	PK2913DT	RBD245A-V

Motor Cable for IP65 Rated Motor (Sold separately) RoHS

A cable for connection between the IP65 rated motor and driver (with protective earth wire).

Product Line

Model	Length m (ft.)	Conductors
CC03PKT	3 (9.8)	6

- Conductor configuration: 6
- Conductor size: Motor wire AWG18 (0.75 mm²), protective earth wire AWG14 (2.0 mm²)
- Finished outer diameter: φ12 mm (φ0.47 inch)
- Cable rating: 105°C (221°F) 600 V
- Outer casing: Heat-resistant, oil-resistant vinyl chloride resin
- Applicable standards: UL 758 (AWM) VW-1, UL Style 2586

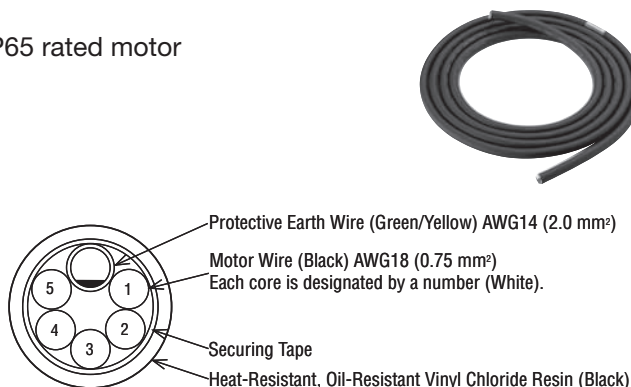

Flexible Couplings (Sold separately) RoHS

A flexible coupling ideal for your motor is available. Once you have decided on a motor, you can select the recommended coupling easily. All motor shaft diameters are available.

Features of MCS Couplings

This three-piece coupling utilizes an aluminum alloy hub and a resin spider. The simple construction ensures that the high torque generated by a geared motor can be transmitted reliably. The proper elasticity of the spider suppresses motor vibration.

- The resin spider (material: polyurethane) controls the vibration generated by the motor.
- No backlash

Coupling Selection Table

Frame Size 56.4 mm (2.22 inch)

Applicable Motor Model	Motor Shaft Diameter mm (inch)	Coupling Model	Connected Device Shaft Diameter mm (inch)
RBK264 □ RBK264T RBK266 □ RBK266T	φ6.35 (φ0.25)	MCS2005F04	φ5 (φ0.1969)
		MCS2006F04	φ6 (φ0.2362)
		MCS20F04F04	φ6.35 (φ0.25)
		MCS20F0408	φ8 (φ0.315)
		MCS20F0410	φ10 (φ0.3937)
RBK268 □ RBK268T	φ6.35 (φ0.25)	MCS3006F04	φ6 (φ0.2362)
		MCS30F04F04	φ6.35 (φ0.25)
		MCS30F0408	φ8 (φ0.315)
		MCS30F0410	φ10 (φ0.3937)

Enter **A** (single shaft) or **B** (double shaft) in the box (□) within the model name.

Product Number Code

MCS 30 6 F04

① ② ③ ④

①	MCS Couplings
②	Outer Diameter of Coupling
③	Inner Diameter d1 (Smaller Side) [F04 represents φ6.35 mm (φ0.25 inch)]
④	Inner Diameter d2 (Larger Side) [F04 represents φ6.35 mm (φ0.25 inch)]

Frame Size 85 mm (3.35 inch)

Applicable Motor Model	Motor Shaft Diameter mm (inch)	Coupling Model	Connected Device Shaft Diameter mm (inch)
RBK296T	φ14 (φ0.5512)	MCS301014	φ10 (φ0.3937)
		MCS301214	φ12 (φ0.4724)
		MCS301414	φ14 (φ0.5512)
		MCS301416	φ16 (φ0.6299)
RBK299T RBK2913T	φ14 (φ0.5512)	MCS551214	φ12 (φ0.4724)
		MCS551414	φ14 (φ0.5512)
		MCS551415	φ15 (φ0.5906)
		MCS551416	φ16 (φ0.6299)

Motor Mounting Brackets (Sold separately) RoHS

Mounting brackets are convenient for installation and securing a stepping motor.

Product Line

Material: Aluminum alloy

Model	Applicable Product
PAL2P-2	RBK264□, RBK266□, RBK268□ RBK264T, RBK266T, RBK268T
PAL4P-2	RBK296□A, RBK299□A, RBK2913□A RBK296T, RBK299T, RBK2913T

- Enter **A** (single shaft) or **B** (double shaft) in the box (□) within the model name.
- The mounting bracket base is built with holes large enough to allow for alignment adjustments in the horizontal direction.
- These mounting brackets can be perfectly fitted to the pilot of the stepping motors.



Clean Dampers (Sold separately) RoHS

Mechanical dampers suppress stepping motor vibration and improve high-speed performance. An inertia body and silicon gel are hermetically sealed in a plastic case.

Features

- Excellent vibration absorption
The doughnut-shaped internal inertia body and silicon gel absorb vibration. This feature enables a stable damping effect.
- Since there is no frictional dust as in conventional magnetic dampers, it can be used in environments where higher degrees of cleanliness is needed.
- High reliability
- It holds up well in harsh environments and changes little with age because the silicon gel and plastic case used are heat resistant.
- Machine part is sealed hermetically in a plastic case. This ensures safety and doesn't generate noise.
- This clean damper is an accessory for double shaft types. It can be used with various geared motors of double shaft type.

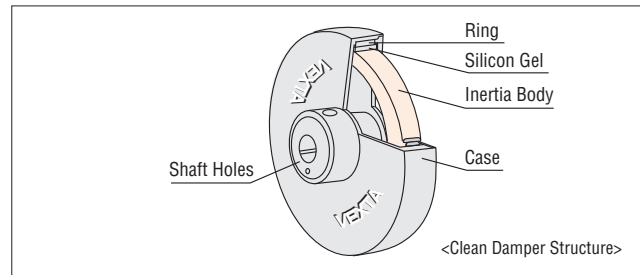

Product Line

Model	Inertia kg·m ² (oz·in ²)	Mass g (lb.)	Applicable Product
D6CL-6.3F	140×10 ⁻⁷ (0.77)	62 (0.14)	RBK264B, RBK266B, RBK268B
D9CL-12.7F	870×10 ⁻⁷ (4.8)	105 (0.23)	RBK296BA, RBK299BA, RBK2913BA

● Ambient Temperature: -20~+80°C (-4~+176°F)

DIN Rail Mounting Plate (Sold separately) RoHS

(Available when the input voltage to the driver is 48 VDC or less)

This mounting plate is convenient for installing the driver of **RBK** Series on DIN rails with ease.

Note:

- If the driver's input power-supply voltage exceeds 48 VDC, do not install the driver onto a DIN rail. Sufficient heat dissipation cannot be achieved and the driver's overheat protective function may be activated as a result. In such a case, install the driver onto a metal plate directly.

Model: **PADP01**



Controller (Sold separately)

Programmable Motion Controller EMP400 Series RoHS

Features

Combining innovations from Oriental Motor's expertise as a motor manufacturer to offer a full-scale oscillation function, a sequence function for programming a series of operations, and an I/O control function.

- Allowing the Input of 32 Sequence Programs
- Various Operation Patterns
- Teaching Function

You can adjust the travel amount or monitor the current position via teaching, using an accessory operator interface unit **OP300**.

- No Need for Dedicated Software

Sample Program

Positioning Operation

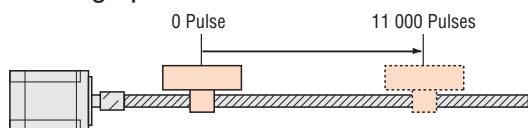

Accessories (Sold separately)

We have a range of accessory cables that achieve one-touch connection between the **EMP400** Series and peripherals, as well as an operator interface unit used for teaching operation.

Operator Interface Unit **OP300** RoHS

You can set the travel amount via teaching or monitor the current position.

- Used for the **EMP** Series

Use the included cable [length: 2 m (6.6 ft.)] for connection with the **EMP** Series.



Connector – Terminal Block Conversion Unit **CC50T1** RoHS

A conversion unit that connects a half-pitch connector of the **EMP** Series using a terminal block (Cable length: 1 m).

- Includes a signal name plate for easy, one-glance identification of driver signal names.
- DIN-rail mountable
- Cable length: 1 m



Single Axis

Dual Axis

Operator Interface Unit
(Sold separately)
(A Communication cable
of 2 m is included.)

Product Line

Model	Number of Axes	Connector
EMP401-1	Single axis	Without connectors
EMP401-2		With connectors
EMP402-1	Dual axis	Without connectors
EMP402-2		With connectors

Operator Interface Unit **OP300**

- [1]VS1_500 : Starting speed 500 Hz
- [2]V1_1000 : Operating speed 1000 Hz
- [3]T1_30.0 : Acceleration/deceleration rate 30.0 ms/kHz
- [4]D1_+11000 : Travel amount 11 000 pulses in CW direction
- [5]INC1 : Execute relative positioning operation

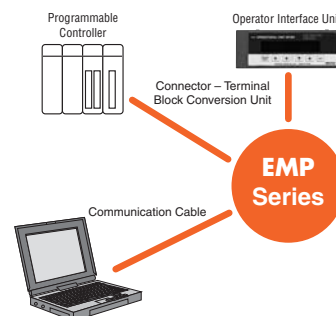

Communication Cable **FC04W5** RoHS

A communication cable [length 5 m (16.4 ft.)] for connecting the **EMP** Series to a PC. A D-sub, 9-pin (female) connector is attached on the PC end of the communication cable.

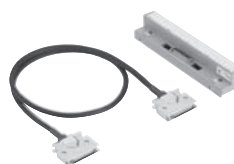

This product is manufactured at a plant certified with the international standards **ISO 9001** (for quality assurance) and **ISO 14001** (for systems of environmental management).

Specifications are subject to change without notice.
This catalog was published in August, 2007.

ORIENTAL MOTOR U.S.A. CORP.

Western Sales and Customer Service Center

Tel: (310) 715-3301 Fax: (310) 225-2594

Dallas

Tel: (214) 432-3386

Los Angeles

Tel: (310) 715-3301

San Jose

Tel: (408) 392-9735

Midwest Sales and Customer Service Center

Tel: (847) 285-5100 Fax: (847) 843-4121

Chicago

Tel: (847) 285-5100

Toronto

Tel: (905) 502-5333

Eastern Sales and Customer Service Center

Tel: (781) 848-2426 Fax: (781) 848-2617

Boston

Tel: (781) 848-2426

Charlotte

Tel: (704) 696-1036

New York

Tel: (973) 359-1100

Technical Support

Tel: (800) 468-3982 / 8:30 A.M. to 5:00 P.M., P.S.T. (M-F)
7:30 A.M. to 5:00 P.M., C.S.T. (M-F)

E-mail: techsupport@orientalmotor.com

Obtain Specifications, Online Training and Purchase Products at:

www.orientalmotor.com

